

**SPECIFICATION
FOR
LCM MODULE**

**MODULE NO.:TFT-0124-CT
DOC. REVISION01**

Customer Approval:

--

	SIGNATURE	DATE
PREPARED BY (RD ENGINEER)		
PREPARED BY (QA ENGINEER)		
CHECKED BY		
APPROVED BY		

WRITTEN BY	CHECKED BY	APPROVED BY

Notes:

- 1、 Please contact **GTK** before assigning your product based on this module specification.
- 2、 To improve the quality of product, and this product specification is subject to change without any notice.

CONTENTS

■ GENERAL INFORMATION.....	4
■ ABSOLUTE MAXIMUM RATINGS.....	4
■ ELECTRICAL CHARACTERISTICS.....	4
■ BACKLIGHT CHARACTERISTICS.....	4
■ EXTERNAL DIMENSIONS.....	5
■ ELECTRO-OPTICAL CHARACTERISTICS.....	6
■ INTERFACE DESCRIPTION.....	8
■ AC CHARACTERISTICS.....	9
■ POWER SEQUENCE.....	11
■ REFERENCE APPLICATION CIRCUIT.....	12
■ RELIABILITY TEST CONDITIONS.....	13
■ INSPECTION CRITERION.....	14
■ PACKING SPECIFICATION.....	19

■ GENERAL INFORMATION

Item of general information	Contents	Unit
LCD size	3.5 inch (Digital)	/
LCD type	TFT/TRANSMISSIVE normal white	
View direction	12 o'clock	
Resolution	320*3(RGB)*240	
Module size (W × H×T)	76.9(W)×63.9(H)×4.55(D)	mm ³
Active area (W×H)	70.08(H)×52.56(V)	mm ²
Pixel pitch (W × H)	0.219(H)×0.219(V)	mm ²
Interface Type	RGB interface	/
Input voltage	3.3V	V
Module Power consumption	TBD	mw
Backlight Type	6*LED	/

■ ABSOLUTE MAXIMUM RATINGS

Parameter	Symbol	Min	Max	Unit
Power supply voltage	DVDD	-0.3	3.6	V
Logic Signal Input Level	Vi	-0.3	DVDD+0.3	V
Operating temperature	Top	-20	70	°C
Storage temperature	TST	-30	80	°C
Humidity	RH	-	90%(Max60 °C)	RH

■ ELECTRICAL CHARACTERISTICS

DC CHARACTERISTICS

Parameter	Symbol	Min	Typ	Max	Unit
Supply Voltage	VDD	3.0	3.3	3.6	V
Current of power supply	IVDD	-	TBD	-	mA
Input voltage 'H' level	VIH	0.7DVDD	-	VDD	V
Input voltage 'L' level	VIL	0	-	0.3VDD	V

Note: Be sure to apply DVDD and VGL to the LCD first , then apply VGH.

■ BACKLIGHT CHARACTERISTICS

Item of backlight characteristics	Symbol	Min.	Typ.	Max.	Unit	Condition
Forward voltage	Vf	-	19.2	19.8	V	Note 1
Current for LED backlight	IL	-	20	22	mA	Note 1
LED life time		50,000	-	-	Hour	Note 2

Note 1: The LED Supply Voltage is defined by the number of LED at Ta=25°C and IL =20mA for each LED.

Note 2: The "LED life time" is defined as the module brightness decrease to 50% original brightness at Ta=25°C and IL =20mA. The LED lifetime could be decreased if operating IL is larger than 20 mA.

EXTERNAL DIMENSIONS

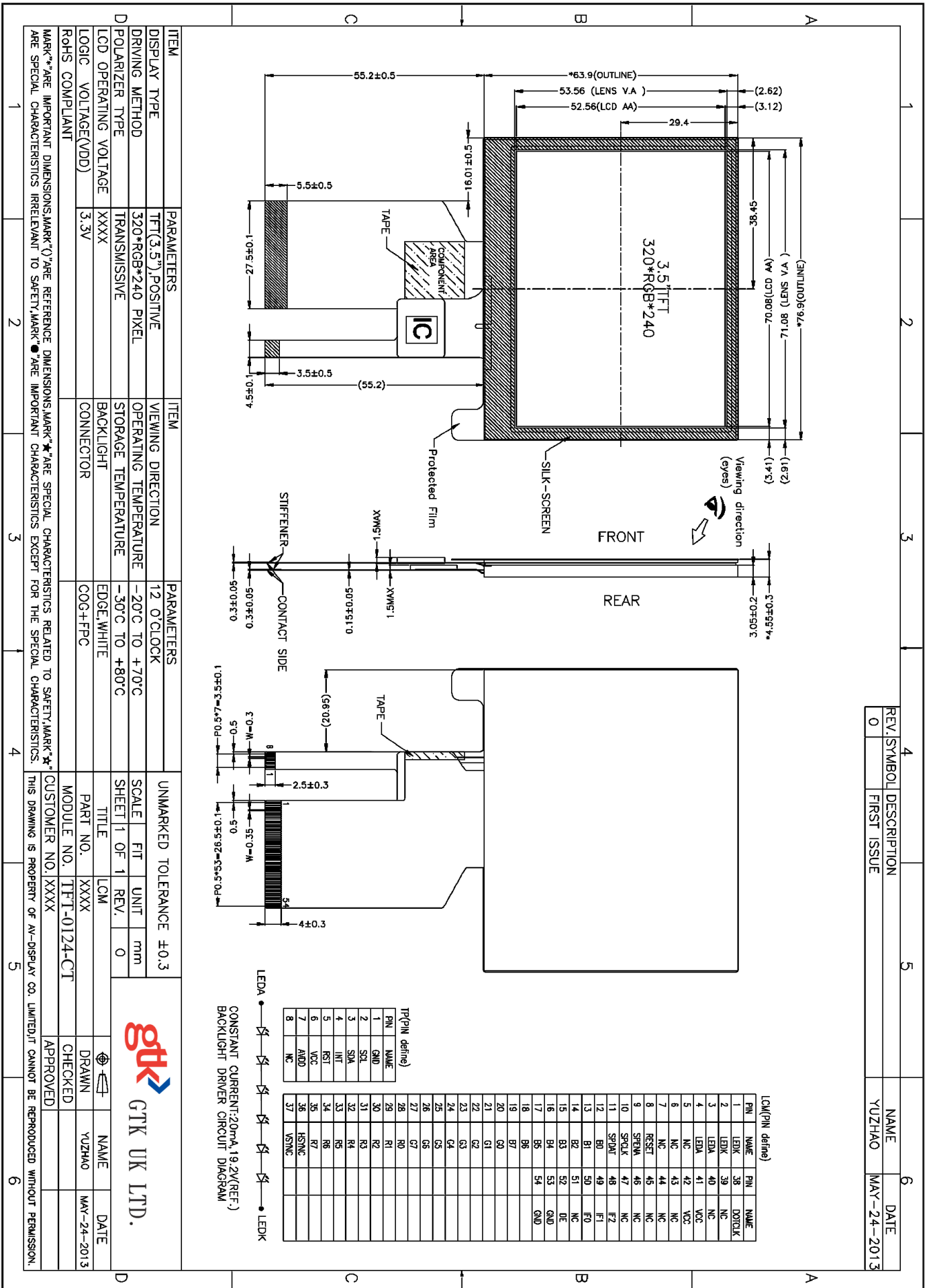

REV.	SYMBOL	DESCRIPTION	NAME	DATE
0		FIRST ISSUE	YUZHAO	MAY-24-2013

ITEM	PARAMETERS	ITEM	PARAMETERS	UNMARKED TOLERANCE	SCALE	FIT	UNIT	REV.	REV.	TITLE	MODULE NO.	TFT-0124-CT	APPROVED
DISPLAY TYPE	TFT(3.5") POSITIVE	VIEWING DIRECTION	12 O'CLOCK	±0.3	1:1	1	mm	0	0	LCM	XXXX	XXXX	DRAWN
DRIVING METHOD	320*RGB*240 PIXEL	OPERATING TEMPERATURE	-20°C TO +70°C										CHECKED
POLARIZER TYPE	TRANSMISSIVE	STORAGE TEMPERATURE	-30°C TO +80°C										YUZHAO
LCD OPERATING VOLTAGE	XXXX	BACKLIGHT	EDGE WHITE										
LOGIC VOLTAGE(VDD)	3.3V	CONNECTOR	COG+FPIC										
ROHS COMPLIANT													

TP(PIN define)

1	NAME	30	R1
2	GND	31	R2
3	SQL	32	R3
4	SDA	33	R4
5	RST	34	R5
6	VCC	35	R6
7	AVDD	36	R7
8	NC	37	R8

LCM(PIN define)

1	LEDK	38	DOCLK
2	LEDK	39	NC
3	LEDK	40	NC
4	LEDK	41	VCC
5	NC	42	VCC
6	NC	43	NC
7	NC	44	NC
8	RESST	45	NC
9	STENA	46	NC
10	SPCLK	47	NC
11	SPDAT	48	F2
12	B0	49	F1
13	B1	50	F0
14	B2	51	NC
15	B3	52	DE
16	B4	53	GND
17	B5	54	GND
18	B6		
19	B7		
20	B0		
21	G1		
22	G2		
23	G3		
24	G4		
25	G5		
26	G6		
27	G7		
28	R0		
29	R1		
30	R2		
31	R3		
32	R4		
33	R5		
34	R6		
35	R7		
36	HSNC		
37	HSNC		

LEDK ← — — — — — LEDK
 CONSTANT CURRENT: 20mA, 19.2V(REF.)
 BACKLIGHT DRIVER CIRCUIT DIAGRAM



■ ELECTRO-OPTICAL CHARACTERISTICS

Item of electro-optical characteristics	Symbol	Condition	Min	Typ	Max	Unit	Remark	Note
Response time	Tr+ Tf		–	25	50	ms	Fig.1	4
Contrast ratio	Cr		400	500	–	---	FIG 2.	1
Luminance uniformity	δ WHITE		60	75	–	%	FIG 2.	3
Surface Luminance	Lv		320	350	–	cd/m ²	FIG 2.	2
Viewing angle range	θ	∅ = 90°	60	70	–	deg	FIG 3.	6
		∅ = 270°	50	60	–	deg	FIG 3.	
		∅ = 0°	60	70	–	deg	FIG 3.	
		∅ = 180°	60	70	–	deg	FIG 3.	
CIE (x, y) chromaticity	Red x	θ=0° ∅=0° Ta=25°C	0.568	0.618	0.668	-	FIG 2.	5
	Red y		0.267	0.317	0.367	-		
	Green x		0.250	0.300	0.350	-		
	Green y		0.514	0.564	0.614	-		
	Blue x		0.088	0.138	0.188	-		
	Blue y		0.109	0.159	0.209	-		
	White x		0.250	0.300	0.350	-		
	White y		0.306	0.356	0.406	-		

Note1. Contrast Ratio(CR) is defined mathematically by the following formula. For more information see FIG 2.:

$$\text{Contrast Ratio} = \frac{\text{Average Surface Luminance with all white pixels (P1, P2, P3, P4, P5)}}{\text{Average Surface Luminance with all black pixels (P1, P2, P3, P4, P5)}}$$

Note2. Surface luminance is the LCD surface from the surface with all pixels displaying white. For more information see FIG 2.

$$L_v = \text{Average Surface Luminance with all white pixels (P1, P2, P3, P4, P5)}$$

Note3. The uniformity in surface luminance (δ WHITE) is determined by measuring luminance at each test position 1 through 5, and then dividing the maximum luminance of 5 points luminance by minimum luminance of 5 points luminance. For more information see FIG 2.

$$\delta \text{ WHITE} = \frac{\text{Minimum Surface Luminance with all white pixels (P1, P2, P3, P4, P5)}}{\text{Maximum Surface Luminance with all white pixels (P1, P2, P3, P4, P5)}}$$

Note4. Response time is the time required for the display to transition from White to black(Rise Time, Tr) and from black to white(Decay Time, Tf). For additional information see FIG 1..

Note5. CIE (x, y) chromaticity ,The x,y value is determined by screen active area position NO.5 For more information see FIG 2.

Note6. Viewing angle is the angle at which the contrast ratio is greater than 2. For TFT module the contrast ratio is greater than 10. The angles are determined for the horizontal or x axis and the vertical or y axis with respect to the z axis which is normal to the LCD surface. For more information see FIG 3.

Note7. For Viewing angle and response time testing, the testing data is base on Autronic-Melchers's ConoScope. Series Instruments. For contrast ratio, Surface Luminance, Luminance uniformity and CIE, the testing data is base on TOPCON's BM-5 photo detector or compatible.

Note8. For TFT module, Gray scale reverse occurs in the direction of panel viewing angle

FIG.1. The definition of Response Time

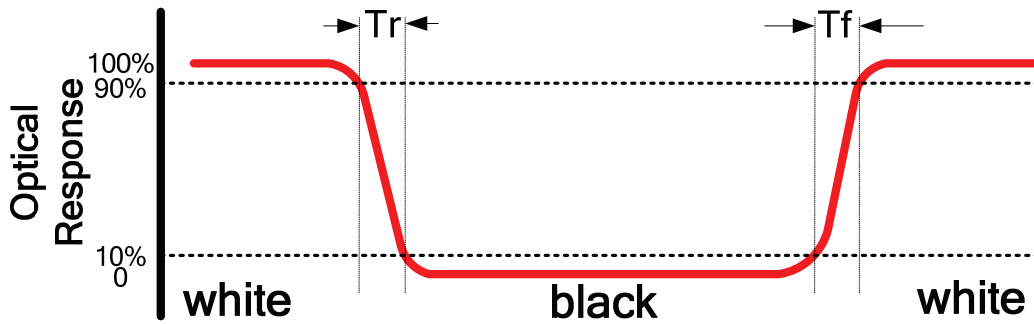

FIG.2. Measuring method for Contrast ratio, surface luminance, Luminance uniformity, CIE (x, y) chromaticity

A : 5 mm
 B : 5 mm
 H, V : Active Area
 Light spot size $\varnothing=5\text{mm}$, 500mm distance from the LCD surface to detector lens
 measurement instrument is TOPCON's luminance meter BM-5

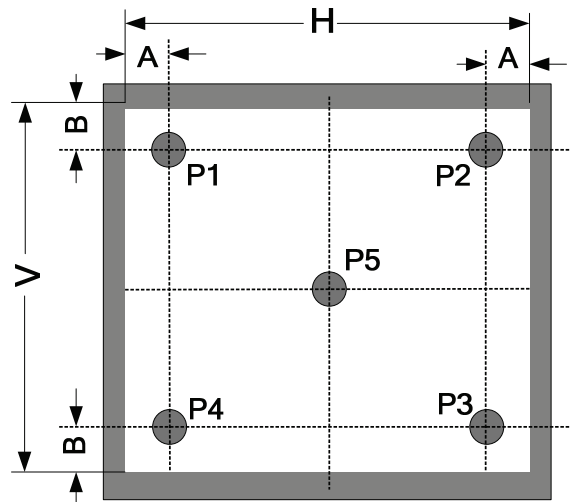
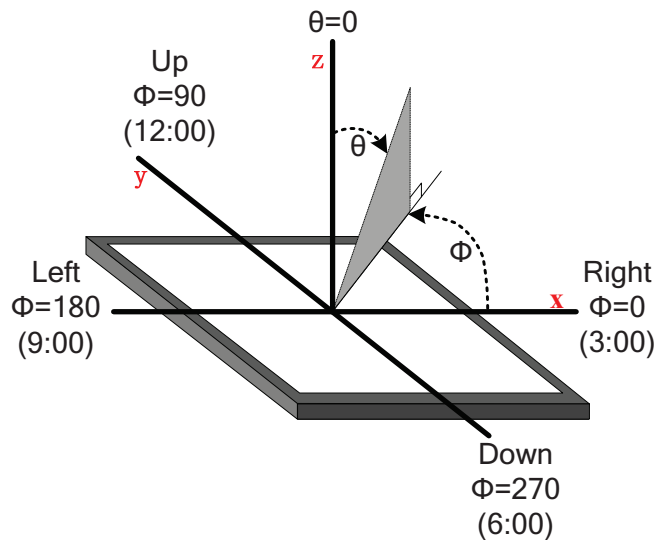

FIG.3. The definition of viewing angle



■ INTERFACE DESCRIPTION

LCM Interface description

Interface NO.	NAME	I/O or connect to	DESCRIPTION	REMARK
1-2	LEDK	P	Power for LED backlight(Cathode)	
3-4	LEDA	P	Power for LED backlight(Anode)	
5-7	NC	/	/	
8	RESET	I	Hardware Reset	
9	SPENA	I	SPI Interface Data Enable Signal	
10	SPCLK	I	SPI Interface Data Clock	
11	SPDAT	I	SPI Interface Data	
12-19	Blue(0-7)	I	Blue Data Bit(0-7)	
20-27	Green(0-7)	I	Green Data Bit(0-7)	
28-35	Red(0-7)	I	Red Data Bit(0-7)/DX(0-7)	
36	HSYNC	I	Horizontal Sync Input	
37	VSYNC	I	Vertical Sync Input	
38	DOTCLK	I	Dot Data Clock	
39-40	NC	/	/	
41-42	VCC	P	Digital Power	
43-47	NC	/	/	
48	IF2	I	floating	
49	IF1	I	floating	
50	IF0	I	floating	
51	NC	/	/	
52	DE	I	Data Enable Input	
53-54	GND	P	Ground	

CTP Interface description

Interface NO.	NAME	I/O or connect to	DESCRIPTION	REMARK
1	GND	P	Ground	
2	SCL	I	Serial interface clock	
3	SDA	I/O	Serial interface data	
4	INT	O	State change interrupt	
5	RST	I	Reset low	
6	VCC	P	Digital Power of CTP	
7	AVDD	P	Analog power of CTP	
8	NC	/	/	

■ AC CHARACTERISTICS

Item	Symbol	Min	Typ	Max	Unit	Remark
HS setup time	T _{hst}	8	-	-	ns	
HS hold time	T _{hhd}	8	-	-	ns	
VS setup time	T _{vst}	8	-	-	ns	
VS hold time	T _{vhd}	8	-	-	ns	
Data setup time	T _{dsu}	8	-	-	ns	
Data hold time	T _{dhd}	8	-	-	ns	
DE setup time	T _{esu}	8	-	-	ns	
DE hold time	T _{ehd}	8	-	-	ns	
Dvdd power on slew rate	T _{por}	-	-	20	ms	0 to 90% DVDD
RESET pulse width	T _{rst}	1	-	-	us	
DCLK cycle time	T _{coh}	20	-	-	ns	
DCLK pulse duty	T _{cwh}	40	50	60	%	

Timing Diagram of Interface Signal

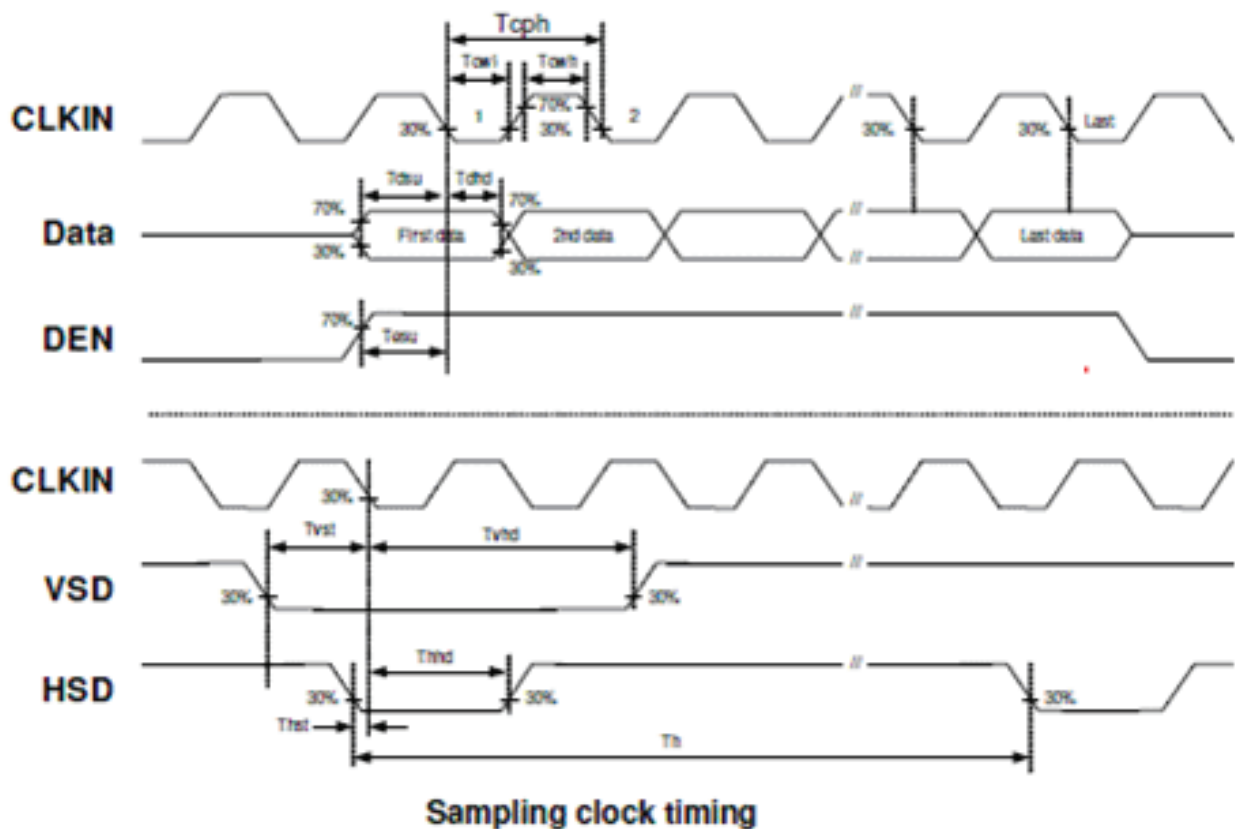

Item	Symbol	Min	Typ	Max	Unit	Remark
Horizontal Display Area	thd		320		DCLK	
Dclk frequency	felk	-	6.4	9	MHZ	
One horizontal line	th	408	428	605	DCLK	
HS pulse width	thpw	1	-	-	DCLK	
HS blanking	thb	70	88	-	DCLK	
HS front porch	thfp	10	16	-	DCLK	
Vertical Display Area	tvd		240		TH	
VS period time	tv	263	276	320	TH	
VS pulse width	tvpw	1	-	-	TH	
VS blanking	tvb	13	24	-	TH	
VS front porch	tvfp	10	12	-	TH	

Horizontal input timing diagram.

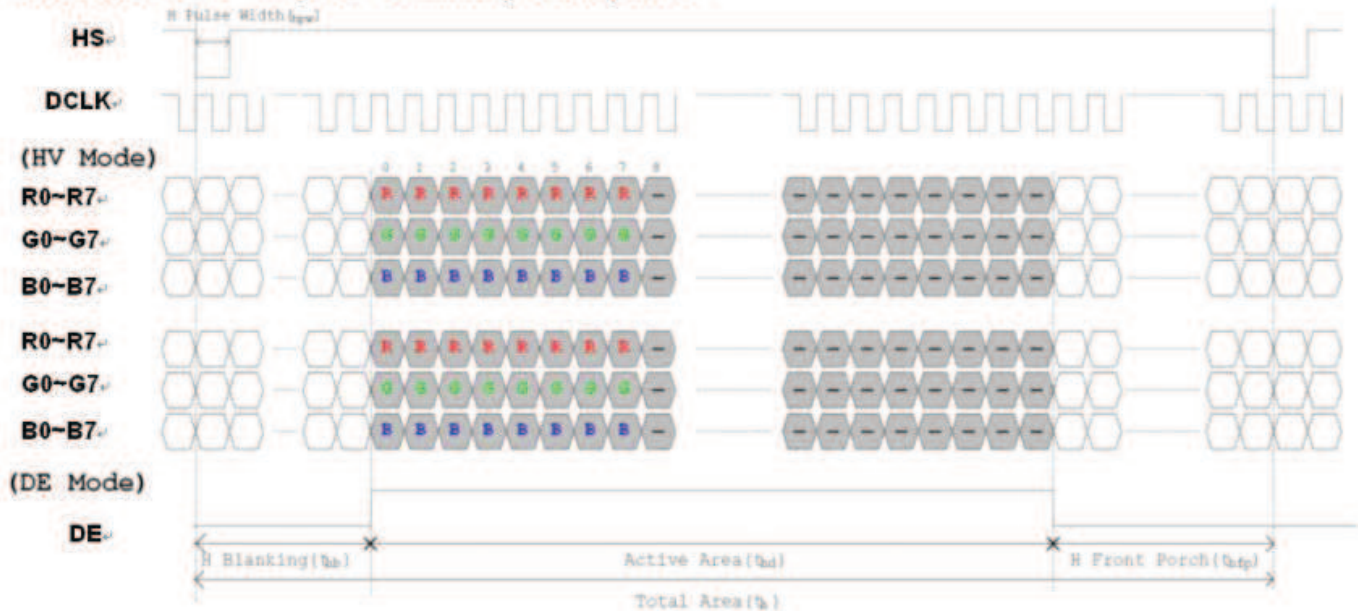

Vertical input timing diagram.

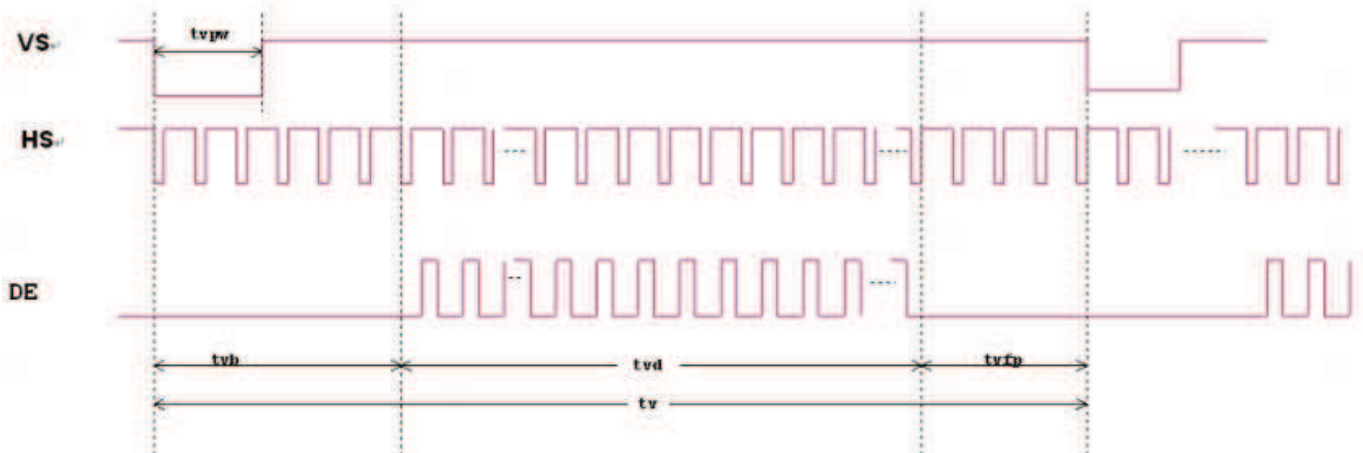

■ POWER SEQUENCE

a. Power on:

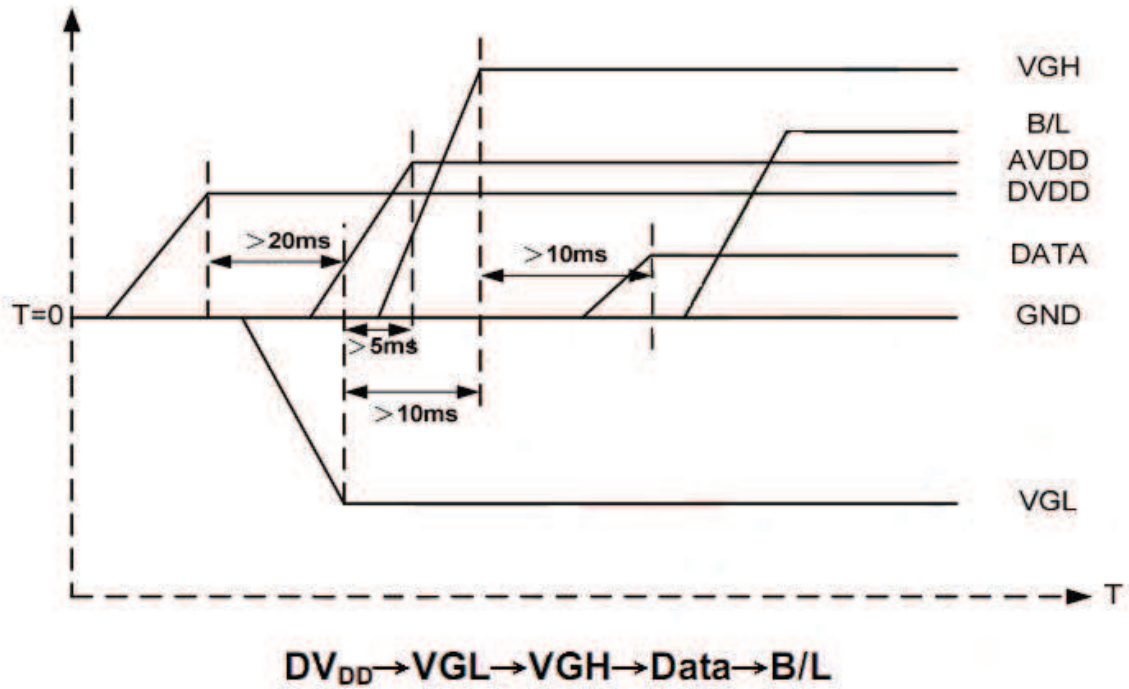

b. Power off:

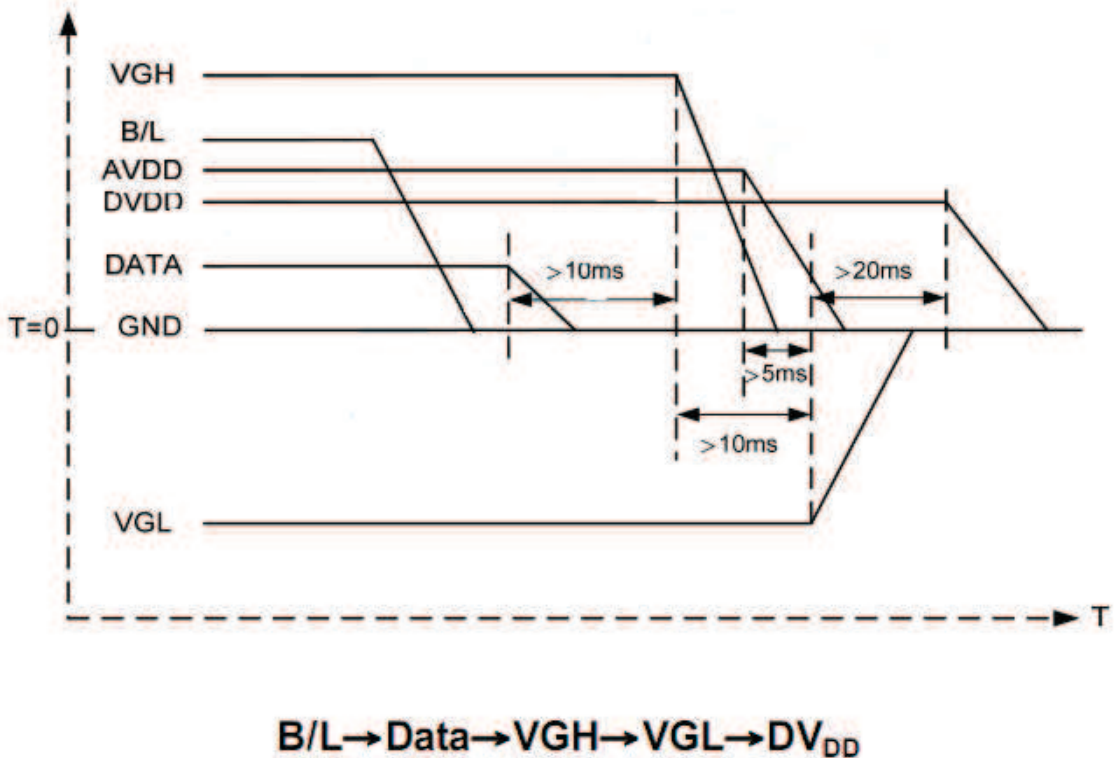

Note: Data include R0~R7, B0~B7, GO~G7, U/D, L/R, DCLK, HS, VS, DE.

■ REFERENCE APPLICATION CIRCUIT

Please consult our technical department for detail information.

■ RELIABILITY TEST CONDITIONS

No.	Test Item	Test Condition	Inspection after test
1	High Temperature Storage	80±2°C/240 hours	Inspection after 2~4hours storage at room temperature, the sample shall be free from defects: 1.Air bubble in the LCD; 2.Sealleak; 3.Non-display; 4.missing segments; 5.Glass crack; 6.Current Idd is twice higher than initial value.
2	Low Temperature Storage	-30±2°C/240 hours	
3	High Temperature Operating	70±2°C/120 hours	
4	Low Temperature Operating	-20±2°C/120 hours	
5	Temperature Cycle	-20±2°C~25~70±2°C×10cycles (30min.) (5min.) (30min.)	
6	Damp Proof Test	50°C±5°C×90%RH/120 hours	
7	Vibration Test	Frequency: 10Hz~55Hz~10Hz Amplitude: 1.5mm, X, Y, Z direction for total 3hours (Packing condition)	
8	Dropping test	Drop to the ground from 1m height, one time, every side of carton. (Packing condition)	
9	ESD test	Voltage:±8KV R: 330Ω C: 150pF Air discharge, 10time	

Remark:

- 1.The test samples should be applied to only one test item.
- 2.Sample size for each test item is 5~10pcs.
- 3.For Damp Proof Test, Pure water(Resistance>10MΩ) should be used.
- 4.In case of malfunction defect caused by ESD damage, if it would be recovered to normal state after resetting, it would be judged as a good part.
- 5.EL evaluation should be excepted from reliability test with humidity and temperature: Some defects such as black spot/blemish can happen by natural chemical reaction with humidity and Fluorescence EL has.
- 6.Failure Judgment Criterion: Basic Specification, Electrical Characteristic, Mechanical Characteristic, Optical Characteristic.

■ INSPECTION CRITERION

This specification is made to be used as the standard acceptance/rejection criteria for Normal LCM Product.

1 Sample plan

Sampling plan according to GB/T2828.1-2003/ISO 2859-1 : 1999 and ANSI/ASQC Z1.4-1993, normal level 2 and based on:

Major defect: AQL 0.65

Minor defect: AQL 1.5

2. Inspection condition

● Viewing distance for cosmetic inspection is about 30cm with bare eyes, and under an environment of 20~40W light intensity, all directions for inspecting the sample should be within 45° against perpendicular line. (Normal temperature 20~25°C and normal humidity 60±15%RH).

● Driving voltage

The Vop value from which the most optimal contrast can be obtained near the specified Vop in the specification (Within ±0.5V of the typical value at 25°C.).

3. Definition of inspection zone in LCD.

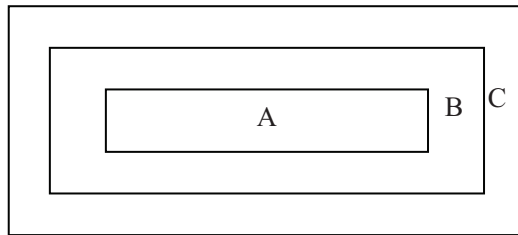

Zone A: character/Digit area

Zone B: viewing area except Zone A (ZoneA+ZoneB=minimum Viewing area)

Zone C: Outside viewing area (invisible area after assembly in customer's product)

Fig.1 Inspection zones in an LCD.

Note: As a general rule, visual defects in Zone C are permissible, when it is no trouble for quality and assembly of customer's product.

4. Inspection Standard

4.1 Major Defect

Item No	Items to be inspected	Inspection Standard	Classification of defects
4.1.1	All functional defects	1) No display 2) Display abnormally 3) Missing vertical, horizontal segment 4) Short circuit 5) Back-light no lighting, flickering and abnormal lighting.	Major
4.1.2	Missing	Missing component	
4.1.3	Outline dimension	Overall outline dimension beyond the drawing is not allowed.	

4.2 Cosmetic Defect

4.2.1 Module Cosmetic Criteria

No.	Item	Judgement Criterion	Partition
1	Difference in Spec.	None allowed	Major
2	Pattern peeling	No substrate pattern peeling and floating	Major
3	Soldering defects	No soldering missing No soldering bridge No cold soldering	Major Major Minor
4	Resist flaw on Printed Circuit Boards	visible copper foil ($\varnothing 0.5\text{mm}$ or more) on substrate pattern	Minor
5	Accretion of metallic Foreign matter	No accretion of metallic foreign matters (Not exceed $\varnothing 0.2\text{mm}$)	Minor Minor
6	Stain	No stain to spoil cosmetic badly	Minor
7	Plate discoloring	No plate fading, rusting and discoloring	Minor
8	Solder amount	a. Soldering side of PCB Solder to form a 'Filet' all around the lead. Solder should not hide the lead form perfectly. (too much)	Minor
	1. Lead parts	b. Components side (In case of 'Through Hole PCB') Solder to reach the Components side of PCB.	
	2. Flat packages	Either 'Toe' (A) or 'Seal' (B) of the lead to be covered by 'Filet'. Lead form to be assume over solder.	
	3. Chips	$(3/2) H \geq h \geq (1/2) H$	Minor

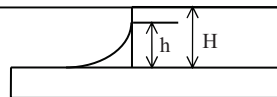
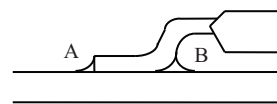
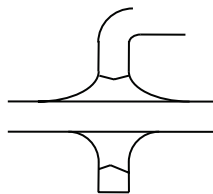

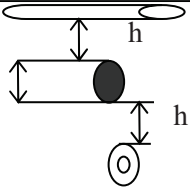
9	Solder splash ball/Solder	<p>a. The spacing between solder ball and the conductor or solder pad $h \geq 0.13\text{mm}$ The diameter of solder ball $d \leq 0.15\text{mm}$.</p> <p>b. The quantity of solder balls or solder Splashes isn't beyond 5 in 600mm^2.</p> <p>c. Solder balls/Solder splashes do not violate minimum electrical clearance.</p> <p>d. Solder balls/Solder splashes must be entrapped/encapsulated Or attached to the metal surface.</p> <p>NOTE: Entrapped/encapsulated/attached is intended to mean that normal service environment of the product will not cause a solder ball to become dislodged.</p>	 <p>Minor</p> <p>Minor</p> <p>Major</p> <p>Minor</p>
---	------------------------------	---	---

4.2.2 Cosmetic Criteria (Non-Operating)

No.	Defect	Judgment Criterion	Partition										
1	Spots	In accordance with <i>Screen Cosmetic Criteria (Operating) No.1.</i>	Minor										
2	Lines	In accordance with <i>Screen Cosmetic Criteria (Operating) No.2.</i>	Minor										
3	Bubbles in polarizer	<table border="1" data-bbox="486 801 1262 981"> <thead> <tr> <th>Size : d mm</th> <th>Acceptable Qty in active area</th> </tr> </thead> <tbody> <tr> <td>$d \leq 0.3$</td> <td>Disregard</td> </tr> <tr> <td>$0.3 < d \leq 1.0$</td> <td>3</td> </tr> <tr> <td>$1.0 < d \leq 1.5$</td> <td>1</td> </tr> <tr> <td>$1.5 < d$</td> <td>0</td> </tr> </tbody> </table>	Size : d mm	Acceptable Qty in active area	$d \leq 0.3$	Disregard	$0.3 < d \leq 1.0$	3	$1.0 < d \leq 1.5$	1	$1.5 < d$	0	Minor
Size : d mm	Acceptable Qty in active area												
$d \leq 0.3$	Disregard												
$0.3 < d \leq 1.0$	3												
$1.0 < d \leq 1.5$	1												
$1.5 < d$	0												
4	Scratch	In accordance with spots and lines operating cosmetic criteria. When the light reflects on the panel surface, the scratches are not to be remarkable.	Minor										
5	Allowable density	Above defects should be separated more than 30mm each other.	Minor										
6	Coloration	Not to be noticeable coloration in the viewing area of the LCD panels. Back-lit type should be judged with back-lit on state only.	Minor										
7	Contamination	Not to be noticeable.	Minor										

4.2.3 Cosmetic Criteria (Operating)

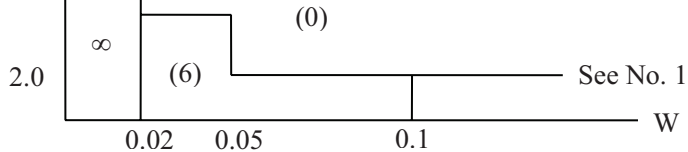
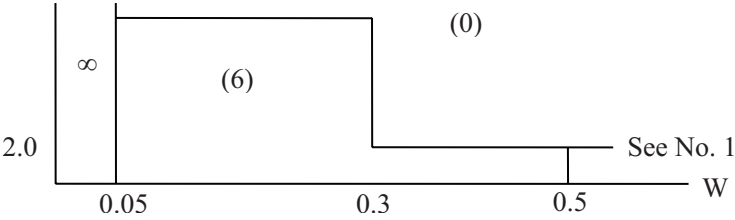
No.	Defect	Judgment Criterion	Partition																																												
1	Spots	<p>A) Clear</p> <table border="1" data-bbox="427 293 1262 622"> <thead> <tr> <th>Lcd size</th> <th>Size : d mm</th> <th>Acceptable Qty in active area</th> </tr> </thead> <tbody> <tr> <td rowspan="4">Lcd size ≤ 8.0'</td> <td>d ≤ 0.1</td> <td>Disregard</td> </tr> <tr> <td>0.1 < d ≤ 0.2</td> <td>6</td> </tr> <tr> <td>0.2 < d ≤ 0.3</td> <td>2</td> </tr> <tr> <td>0.3 < d</td> <td>0</td> </tr> <tr> <td rowspan="4">Lcd size > 8.0'</td> <td>d ≤ 0.1</td> <td>Disregard</td> </tr> <tr> <td>0.1 < d ≤ 0.3</td> <td>10</td> </tr> <tr> <td>0.3 < d ≤ 0.5</td> <td>5</td> </tr> <tr> <td>0.5 < d</td> <td>0</td> </tr> </tbody> </table> <p>Note : Including pin holes and defective dots which must be within one pixel size; Total defective point shall not exceed 6 pcs no more than 8 inch LCD and 10PCS for more than 8 inch LCD.</p> <p>B) Unclear</p> <table border="1" data-bbox="427 815 1262 1196"> <thead> <tr> <th>Lcd size</th> <th>Size : d mm</th> <th>Acceptable Qty in active area</th> </tr> </thead> <tbody> <tr> <td rowspan="4">Lcd size ≤ 8.0'</td> <td>d ≤ 0.2</td> <td>Disregard</td> </tr> <tr> <td>0.2 < d ≤ 0.5</td> <td>6</td> </tr> <tr> <td>0.5 < d ≤ 0.7</td> <td>2</td> </tr> <tr> <td>0.7 < d</td> <td>0</td> </tr> <tr> <td rowspan="5">Lcd size > 8.0'</td> <td>d ≤ 0.2</td> <td>Disregard</td> </tr> <tr> <td>0.2 < d ≤ 0.5</td> <td>10</td> </tr> <tr> <td>0.5 < d ≤ 0.7</td> <td>3</td> </tr> <tr> <td>0.7 < d ≤ 1.0</td> <td>1</td> </tr> <tr> <td>1.0 < d</td> <td>0</td> </tr> </tbody> </table> <p>Note : Total defective point shall not exceed 6 pcs for no more than 8 inch LCD and 10PCS for more than 8 inch LCD.</p>	Lcd size	Size : d mm	Acceptable Qty in active area	Lcd size ≤ 8.0'	d ≤ 0.1	Disregard	0.1 < d ≤ 0.2	6	0.2 < d ≤ 0.3	2	0.3 < d	0	Lcd size > 8.0'	d ≤ 0.1	Disregard	0.1 < d ≤ 0.3	10	0.3 < d ≤ 0.5	5	0.5 < d	0	Lcd size	Size : d mm	Acceptable Qty in active area	Lcd size ≤ 8.0'	d ≤ 0.2	Disregard	0.2 < d ≤ 0.5	6	0.5 < d ≤ 0.7	2	0.7 < d	0	Lcd size > 8.0'	d ≤ 0.2	Disregard	0.2 < d ≤ 0.5	10	0.5 < d ≤ 0.7	3	0.7 < d ≤ 1.0	1	1.0 < d	0	Minor
Lcd size	Size : d mm	Acceptable Qty in active area																																													
Lcd size ≤ 8.0'	d ≤ 0.1	Disregard																																													
	0.1 < d ≤ 0.2	6																																													
	0.2 < d ≤ 0.3	2																																													
	0.3 < d	0																																													
Lcd size > 8.0'	d ≤ 0.1	Disregard																																													
	0.1 < d ≤ 0.3	10																																													
	0.3 < d ≤ 0.5	5																																													
	0.5 < d	0																																													
Lcd size	Size : d mm	Acceptable Qty in active area																																													
Lcd size ≤ 8.0'	d ≤ 0.2	Disregard																																													
	0.2 < d ≤ 0.5	6																																													
	0.5 < d ≤ 0.7	2																																													
	0.7 < d	0																																													
Lcd size > 8.0'	d ≤ 0.2	Disregard																																													
	0.2 < d ≤ 0.5	10																																													
	0.5 < d ≤ 0.7	3																																													
	0.7 < d ≤ 1.0	1																																													
	1.0 < d	0																																													
2	Lines	<p>A) Clear</p>  <p>Note : () - Acceptable Qty in active area L - Length (mm) W - Width (mm) ∞ - Disregard</p> <p>B) Unclear</p>  <p>'Clear' = The shade and size are not changed by V_{op}. 'Unclear' = The shade and size are changed by V_{op}.</p>	Minor																																												

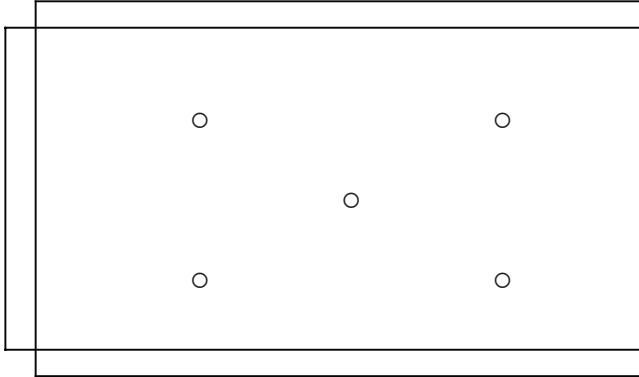
3	Rubbing line	Not to be noticeable.	Minor
4	Allowable density	Above defects should be separated more than 10mm each other.	Minor
5	Rainbow	Not to be noticeable.	Minor
6	Dot size	To be 95% ~ 105% of the dot size (Typ.) in drawing. Partial defects of each dot (ex. pin-hole) should be treated as 'Spot'. (see <i>Screen Cosmetic Criteria (Operating) No.1</i>)	Minor
7	Uneven brightness (only back-lit type module)	<p>Uneven brightness must be $B_{MAX} / B_{MIN} \leq 2$</p> <p>- B_{MAX} : Max. value by measure in 5 points - B_{MIN} : Min. value by measure in 5 points</p> <p>Divide active area into 4 vertically and horizontally. Measure 5 points shown in the following figure.</p>  <p>○ : Measuring points</p>	Minor

Note :

- (1) Size : $d = (\text{long length} + \text{short length}) / 2$
- (2) The limit samples for each item have priority.
- (3) Complex defects are defined item by item, but if the numbers of defects are defined in above table, the total number should not exceed 10.
 - (4) In case of 'concentration', even the spots or the lines of 'disregarded' size should not allowed. Following three situations should be treated as 'concentration'.
 - 7 or over defects in circle of $\varnothing 5\text{mm}$.
 - 10 or over defects in circle of $\varnothing 10\text{mm}$.
 - 20 or over defects in circle of $\varnothing 20\text{mm}$.

■ **PACKING SPECIFICATION**

Please consult our technical department for detail information.