



**SPECIFICATION
FOR
TFT MODULE**

MODULE NO. : IPS102A101A

CUSTOMER NO. :

Rev No. : 0

GTK	PREPARED BY	CHECKED BY	APPROVED BY
SIGNATURE			未九波
DATE	2020.03.27	2020.03.27	2020.03.27

CUSTOMER APPROVAL	SIGNATURE	DATE

Notes :

- 1、 Please contact GTK before assigning your product based on this module specification.
 - 2、 To improve the quality of product, and this product specification is subject to change without any notice.
-

REVISION RECORD

Rev No.	Rev date	Contents	Remarks
0	2020-03-27	First release	Preliminary

CONTENTS

1. GENERAL INFORMATION	3
2. ABSOLUTE MAXIMUM RATINGS.....	3
3. ELECTRICAL CHARACTERISTICS.....	4
4. BACKLIGHT CHARACTERISTICS	5
5. EXTERNAL DIMENSIONS	6
6. ELECTRO-OPTICAL CHARACTERISTICS.....	7
7. INTERFACE DESCRIPTION.....	9
8.AC CHARACTERISTICS	11
9. POWER SEQUENCE.....	12
10. RELIABILITY TEST CONDITIONS	13
11.INSPECTION CRITERION	14
12. HANDLING PRECAUTIONS	14
13. PRECAUTION FOR USE.....	15
14. PACKING SPECIFICATION.....	15
15. INITIALIZATION CODE	15
16. HSF COMPLIANCE	15

OVERVIEW

This specification applies to a 10.25" (10.25" diagonal) TFT Liquid Crystal Display FOG without LED Backlight unit and with 50 pins LVDS interface. This FOG supports 1920 X 720 display mode.

1. GENERAL INFORMATION

No.	Item	Contents	Unit	Note
1	LCD size	10.25 inch (Diagonal)	/	-
2	Driver Element	a-si TFT active matrix	-	-
3	Display mode	Normally Black/Transmissive	/	-
4	Viewing direction(eye)	FREE	/	-
5	Gray scale inversion direction	-	/	-
6	Resolution(H*V)	1920 × R.G.B. × 720	/	-
7	Module size (L*W*H)	261.40*110.70*8.65	mm	-
8	Active area (L*W)	243.65*91.37	mm	-
9	Pixel pitch (L*W)	0.1269(H) × 0.1269(V)	mm	-
10	Interface type	RGB 24bit interface	/	-
11	Color Depth	16.7M	/	-
12	Surface Treatment	HC	-	-
13	Transmittance	4.2	%	Typ.
14	Module power consumption	6590(backlight: 5940)	mW	(1)
15	Back light type	LED	/	-
16	Driver IC	/	/	-
17	Weight	TBD	G	-

Note (1) The specified power consumption (with converter efficiency) is under the conditions at VDD = 3.3 V, f = 60 Hz, and Ta = 25 ± 2 °C, whereas white pattern is displayed.



2. ABSOLUTE MAXIMUM RATINGS

Item	Symbol	Min.	Max.	Unit	Note
Power supply input voltage for TFT	VDD	-0.3	4.0	V	
Backlight current (normal temp.)	ILED	-	50	mA	
Operation temperature	Top	-30	+85	°C	Note1
Storage temperature	Tst	-40	+90	°C	Note1
Humidity	RH	-	90%	RH	Note1

Note1 :

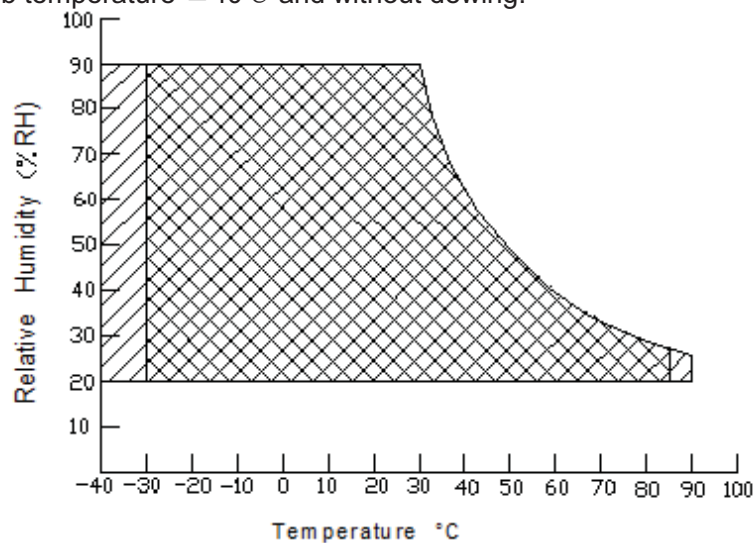
- 1).The relative humidity and temperature range are as below sketch,90%RH Max.
- 2).The maximum wet bulb temperature $\leq 40^{\circ}\text{C}$ and without dewing.



Operating Range  +  Storage Range 

3. ELECTRICAL CHARACTERISTICS

DC CHARACTERISTICS(at Ta=25°C)

Item	Symbol	Min.	Typ.	Max.	Unit	Note
Power supply input voltage	VDD	3.0	3.3	3.6	V	
I/O logic voltage	VDDIO	-	-	-	V	
Input voltage 'H' level	VIH	0.7VDDIO	-	VDDIO	V	
Input voltage 'L' level	VIL	VSS	-	0.3VDDIO	V	
Power supply current	IVDD	-	-	-	mA	
TFT gate on voltage	VGH	-	-	-	V	
TFT gate off voltage	VGL	-	-	-	V	
Analog power supply voltage	AVDD	-	-	-	V	
Differential input common mode voltage	Vcom	-	-	-	V	Note1

Note1 : The value is just the reference value. The customer can optimize the setting value by the different D-IC
 Vcom must be adjusted to optimize display quality, as Crosstalk and Contrast Ratio etc..

BLOCK DIAGRAM

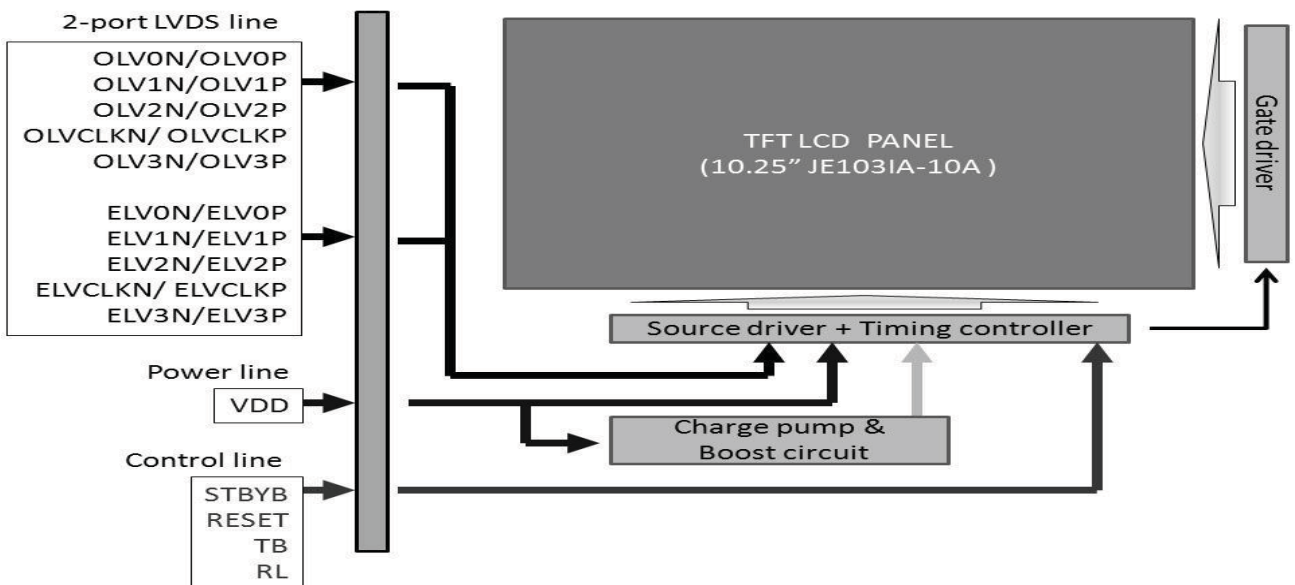
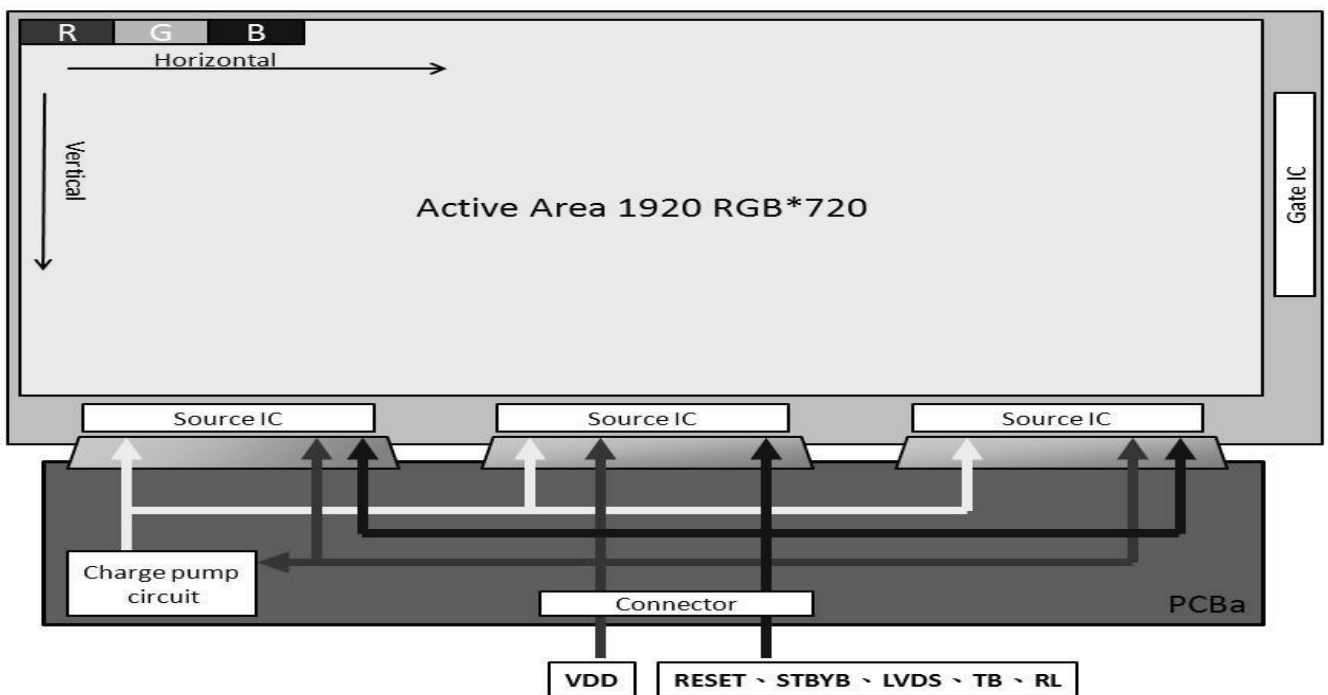

4. BACKLIGHT CHARACTERISTICS

(at Ta=25°C,RH=60%)

Item	Symbol	Min.	Typ.	Max.	Unit	Note
LED forward voltage	VF	24.5	27.0	29.7	V	IF=55*4mA
LED forward current	IF	-	220	-	mA	
LED power consumption	PLED	-	5.94	-	W	Note1
Number of LED	-		36		PCS	
Connection mode	-	9 in series 4 in parallel			/	
LED life-time	-	50000	-	-	Hrs	Note2

Pin No.	Symbol	I/O	Function	Remark
1	LED_A1	P	LED+SUPPLY	
2	LED_A2	P	LED+SUPPLY	
3	LED_A3	P	LED+SUPPLY	
4	LED_A4	P	LED+SUPPLY	
5	NC		NOT USE	
6	NTC1	P	NTC SUPPLY	
7	NTC2	P	NTC SUPPLY	
8	NC		NOT USE	
9	LED_K4	P	LED-	
10	LED_K3	P	LED-	
11	LED_K2	P	LED-	
12	LED_K1	P	LED-	

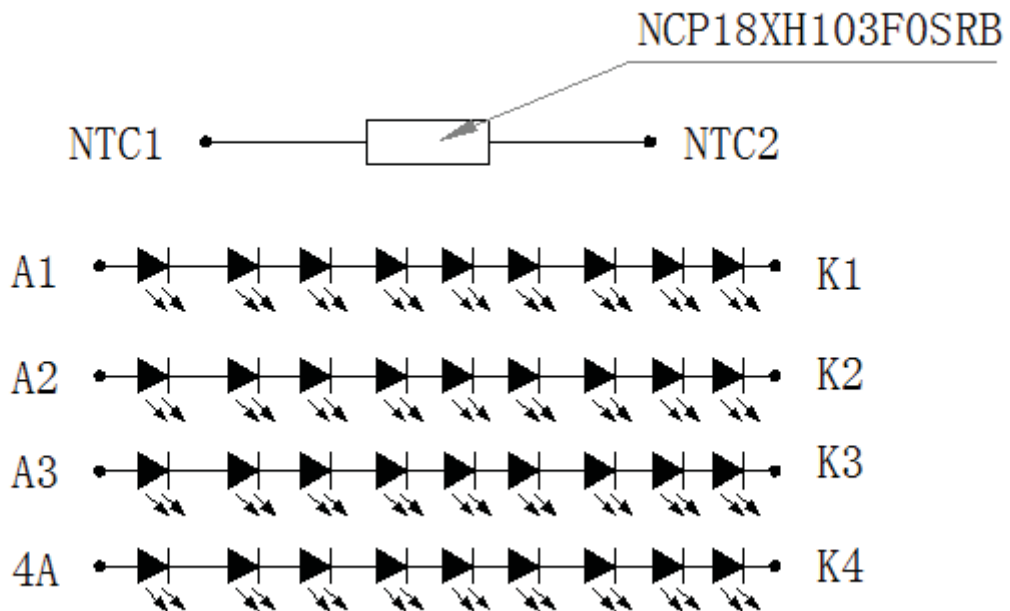

LED Numbers: 36pcs/bar, 1bar/BLU

Note1 : Calculator value for reference : $IF \cdot VF = PLED$

Note2 : The LED life-time define as the estimated time to 50% degradation of initial brightness at Ta=25°C and IF =220mA. The LED lifetime could be decreased if operating IF is larger than 220mA.

5. EXTERNAL DIMENSIONS

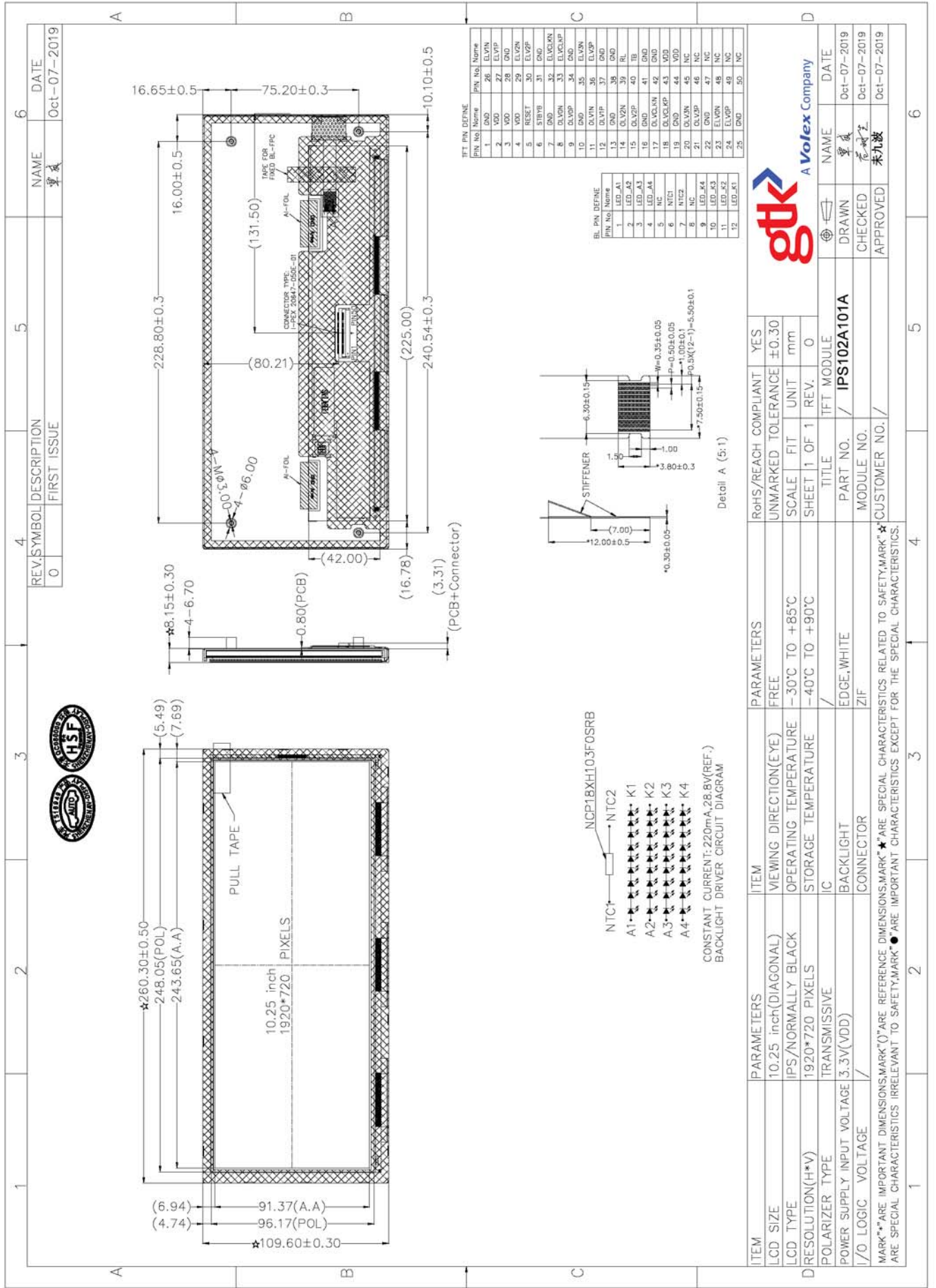

A Volex Company

6. ELECTRO-OPTICAL CHARACTERISTICS

Item	Symbol	Condition	Min.	Typ.	Max.	Unit	Remark	Note
Response time	Tr+ Tf	-	-	25	35	ms	FIG.1	Note 1
Contrast ratio	Cr		700	900	-	-	FIG.2	Note 2
Surface luminance	Lv	$\theta=0^\circ$	500	600	-	cd/m ²	FIG.2	Note 3
Luminance uniformity	Yu	$\theta=0^\circ$	75	-	-	%	FIG.2	Note 4
NTSC	-	$\theta=0^\circ$	62	67	-	%	FIG.2	Note 5
Viewing angle	θ	$\varnothing=90^\circ$	80	-	-	deg	FIG.3	Note 6
		$\varnothing=270^\circ$	80	-	-	deg	FIG.3	
		$\varnothing=0^\circ$	80	-	-	deg	FIG.3	
		$\varnothing=180^\circ$	80	-	-	deg	FIG.3	
CIE (x,y) chromaticity	Red x	$\theta=0^\circ$ $\varnothing=0^\circ$ Ta=25°C	Typ -0.03	0.658	Typ +0.03	-	FIG.2 CIE1931	Note 5
	Red y			0.330		-		
	Green x			0.282		-		
	Green y			0.573		-		
	Blue x			0.134		-		
	Blue y			0.104		-		
	White x			0.313		-		
	White y			0.364		-		

Note1. Definition of response time

The response time is defined as the LCD optical switching time interval between “White” state and “Black”state.Rise time (T_{ON}) is the time between photo detector output intensity changed from 90% to 10%. And fall time (T_{OFF}) is the time between photo detector output intensity changed from 10% to 90%. For additional information see FIG1.

Note2.Definition of contrast ratio

Contrast ratio(Cr) is defined mathematically by the following formula.
For more information see FIG.2.

$$\text{Contrast ratio} = \frac{\text{Luminance measured when LCD on the "White" state}}{\text{Luminance measured when LCD on the "Black" state}}$$

Measured at the center area of the LCD

Note3.Definition of surface luminance

Surface luminance is the luminance with all pixels displaying white.
For more information see FIG.2.

Lv = Average Surface Luminance with all white pixels(P1,P2,P3,,Pn)

Note4.Definition of luminance uniformity

The luminance uniformity in surface luminance is determined by measuring luminance at each test position 1 through n, and then dividing the maximum luminance of n points luminance by minimum luminance of n points luminance.For more information see FIG.2.

$$Y_u = \frac{\text{Minimum surface luminance with all white pixels (P1,P2,P3,.....,Pn)}}{\text{Maximum surface luminance with all white pixels (P1,P2,P3,.....,Pn)}}$$

Note5. Definition of color chromaticity (CIE1931)

CIE (x,y) chromaticity,The x,y value is determined by screen active area center position P5.For more information see FIG.2.

Note6. Definition of viewing angle

Viewing angle is the angle at which the contrast ratio is greater than 10. angles are determined for the horizontal or x axis and the vertical or y axis with respect to the z axis which is normal to the LCD surface.
For more information see FIG.3.

For viewing angle and response time testing, the testing data is base on Autronic-Melchers's ConoScope or DMS series Instruments or compatible. For contrast ratio, Surface Luminance, Luminance uniformity and CIE,the testing data is base on TOPCON's BM-5or BM-7 photo detector or compatible.

FIG.1. The definition of response Time

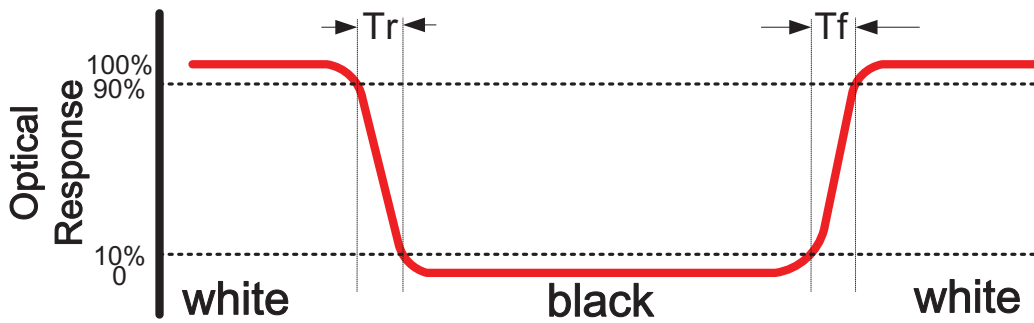

FIG.2. Measuring method for contrast ratio, surface luminance, luminance uniformity, CIE (x,y) chromaticity

H,V : Active area

Light spot size $\varnothing=5\text{mm}$ (BM-5) or $\varnothing=7.7\text{mm}$ (BM-7)50cm distance or compatible distance from the LCM surface to detector lens.

Test spot position : see Figure a.

measurement instrument : TOPCON's luminance meter BM-5 or BM-7 or compatible ,see Figure b.

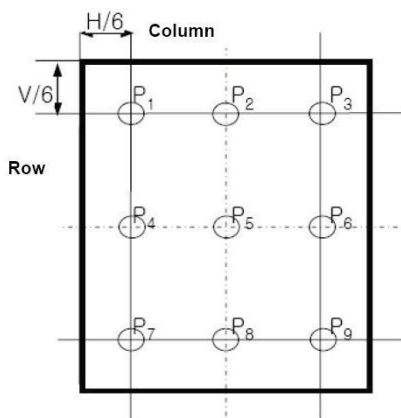

Figure a

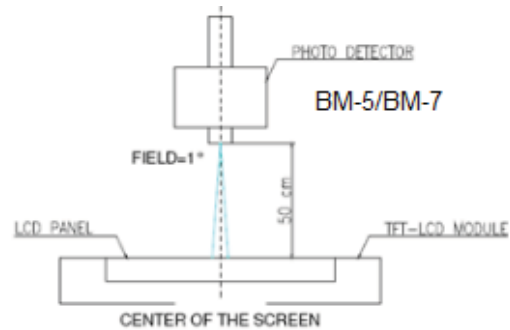
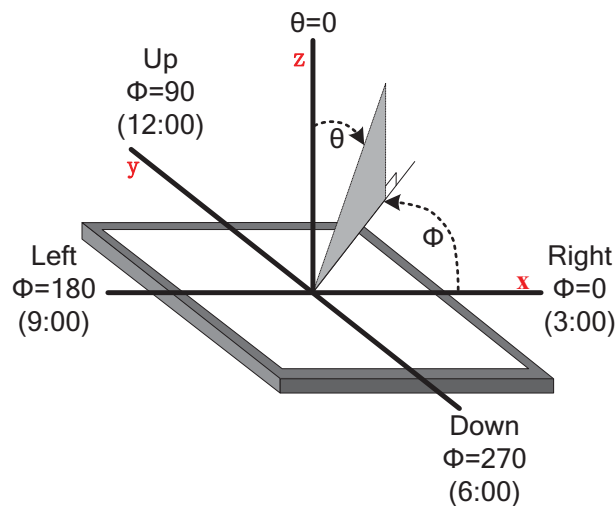

Figure b

FIG.3. The definition of viewing angle



7. INTERFACE DESCRIPTION

Module Interface description

Interface No.	Name	I/O or connect to	Description
1	GND	P	Ground
2-3	VDD	P	External main and I/O power supply ; Power3.3V
4	VDD	P	LCD Maker Use, keep connecting 3.3 V
5	RESET	I	Global reset pin (Default high), active low
6	STBYB	I	Standby mode setting pin (Default high), active low
7	GND	P	Ground
8	OLV0N	I	LVDS odd data 0-
9	OLV0P	I	LVDS odd data 0+
10	GND	P	Ground
11	OLV1N	I	LVDS odd data 1-
12	OLV1P	I	LVDS odd data 1+
13	GND	P	Ground
14	OLV2N	I	LVDS odd data 2-
15	OLV2P	I	LVDS odd data 2+
16	GND	P	Ground
17	OLVCLKN	I	LVDS odd clk -
18	OLVCLKP	I	LVDS odd clk +
19	GND	P	Ground
20	OLV3N	I	LVDS odd data 3-
21	OLV3P	I	LVDS odd data 3+
22	GND	P	Ground
23	ELV0N	I	LVDS even data 0-
24	ELV0P	I	LVDS even data 0+
25	GND	P	Ground
26	ELV1N	I	LVDS even data 1-
27	ELV1P	I	LVDS even data 1+
28	GND	P	Ground
29	ELV2N	I	LVDS even data 2-
30	ELV2P	I	LVDS even data 2+
31	GND	P	Ground
32	ELVCLKN	I	LVDS even clk -
33	ELVCLKP	I	LVDS even clk +
34	GND	P	Ground
35	ELV3N	I	LVDS even data 3-
36	ELV3P	I	LVDS even data 3+
37-38	GND	P	Ground
39	RL	I	Horizontal shift direction (source output) selection. RL = 1: Left -> Right(default: Customer to Pull high, internal IC Pull high*) RL = 0: Right -> Left

40	TB	I	Vertical shift direction (gate output) selection. TB = 0: Bottom->Top TB = 1: Top ->Bottom (default: Customer to Pull high, internal IC Pull high*)
41-42	GND	P	LCD Maker Use,keep connect Ground
43-44	VDD	P	LCD Maker Use,keep connecting 3.3 V
45-50	NC	/	/

Note (1)

SHLR	UPDN	Data Shifting
VDD	VDD	Left→Right, UP→Down(default)
VDD	GND	Left→Right, Down→UP
GND	VDD	Right→Left, UP→Down
GND	GND	Right→Left, Down→UP

Refer to the figure as below :

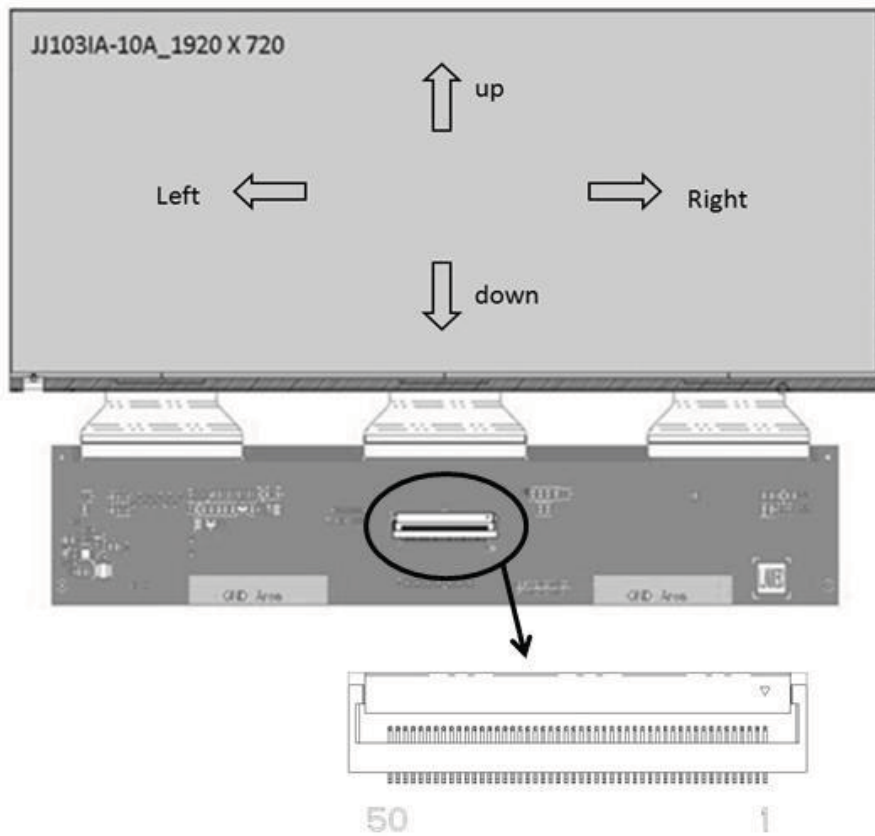

8.AC CHARACTERISTICS

LVDS input timing:

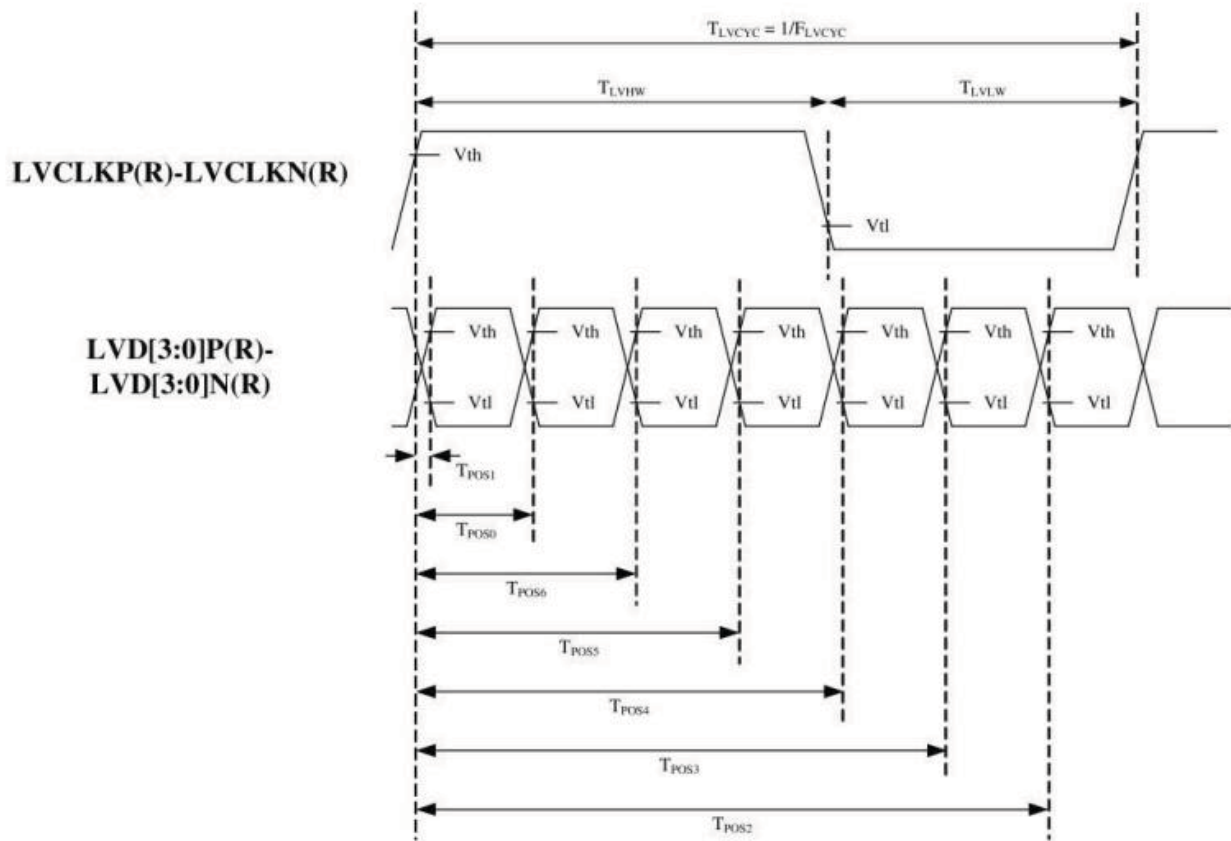

Differential:

LVD[3:0]P-LVD[3:0]N

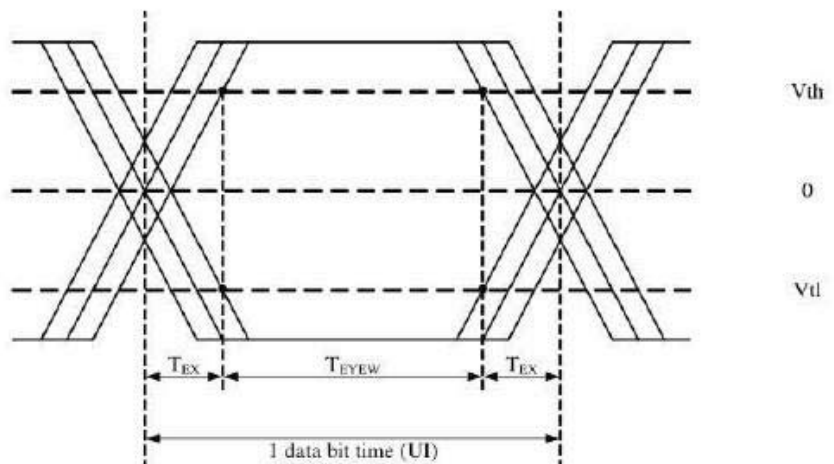

LVDS input eye diagram

9. POWER SEQUENCE

The recommended power on sequence should be: VDD _ RESET _ STBYB. To power off, reverse this sequence, or turn off all signals and power simultaneously.

VDD=3.0~3.6V

Power on :

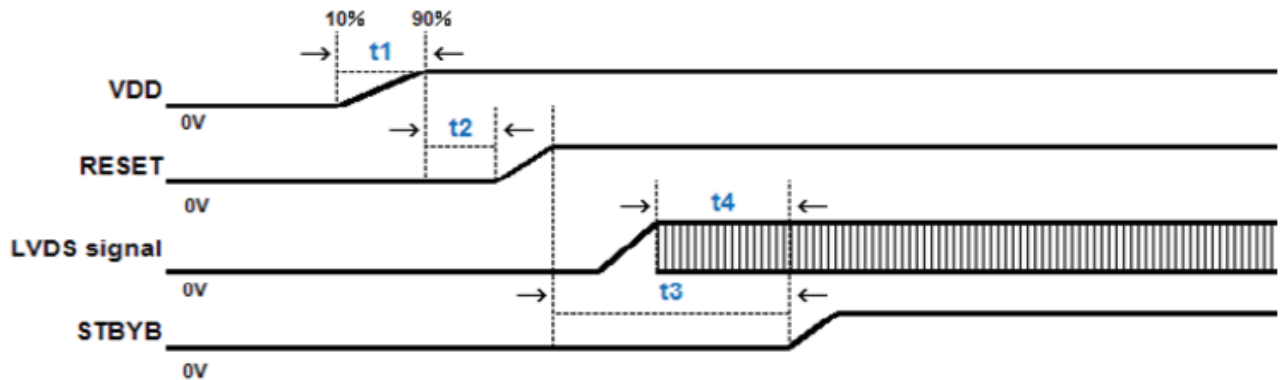

Power off :

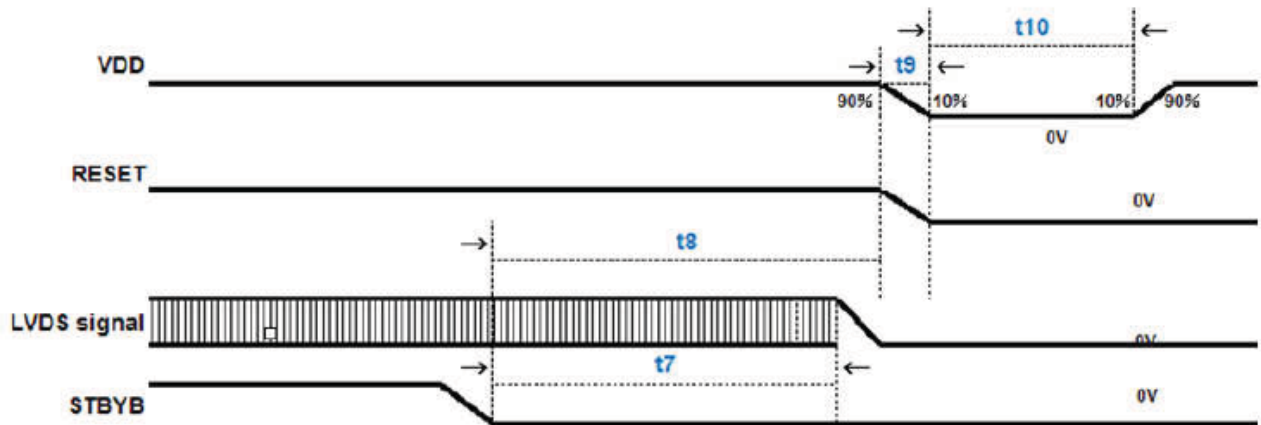

Symbol	SPEC.			Unit
	Min.	Typ.	Max.	
t1	1.5	2	3	ms
t2	1	5	10	ms
t3	0	30	50	ms
t4	0	5	10	ms
t7	7(117)	9(150.3)	10(167)	frame(ms)
t8	8(133.6)	10(167)	11(183.7)	frame(ms)
t9	0	1	3	ms
t10	1000	2000	3000	ms

10. RELIABILITY TEST CONDITIONS

No.	Test item	Test condition	Inspection after test	
10.1	High temperature storage test	+90°C/480 hours	Inspection after 2~4hours storage at room temperature, the sample shall be free from defects : 1.Current changing value before test and after test is 50% larger; 2. Function defect : Non-display,abnormal-d isplay,missing lines, Short lines,I/O corrosion; 3.Visual defect : Air bubble in the LCD,Seal leak,Glass crack.	
10.2	Low temperature storage test	-40°C/480 hours		
10.3	High temperature operating test	+85°C/480 hours		
10.4	Low temperature operating test	-30°C/480 hours		
10.5	Temperature cycle storage test	-30°C ~ 25°C ~ +80°C/100cycles (30min.) (10min.) (30min.)		
10.6	High temperature high humidity test	+60°C*90% RH/500 hours		
10.7	Vibration test	Frequency : 250 r/min Amplitude : 1 inch Time: 45min		
10.8	Drop test	Drop direction: 1 corner/3 edges/6 sides 10 time		
		Packing weight(kg)		Drop height(cm)
		<11		80±1.6
		11≦G<21	60±1.2	
		21≦G<31	50±1.0	
		31≦G<40	40±0.8	
10.9	ESD test	Air discharge: ±15KV, 10time Contact discharge: ±8KV, 10time		

Remark :

- 1.The test samples should be applied to only one test item.
- 2.Sample size for each test item is 3~5pcs.
- 3.For High temperature high humidity test, Pure water(Resistance>10MΩ) should be used.
- 4.In case of malfunction defect caused by ESD damage, if it would be recovered to normal state after resetting, it would be judged as a good part.
- 5.B/L evaluation should be excepted from reliability test with humidity and temperature: Some defects such as black spot/blemish can happen by natural chemical reaction with humidity and Fluorescence B/L has.
- 6.Failure judgment criterion: Basic specification, Electrical characteristic, Mechanical characteristic, Optical characteristic.

11.INSPECTION CRITERION

Refer to 《Inspection Criterion for TFT Products-To customer》 V2.3, DOCUMENT NO.: GTK(WI)-00-QA-007

12. HANDLING PRECAUTIONS

12.1 Mounting method

The LCD module consists of two thin glass plates with polarizes which easily be damaged. And since the module in so constructed as to be fixed by utilizing fitting holes in the printed circuit board.

Extreme care should be needed when handling the LCD modules.

12.2 Caution of LCD handling and cleaning

When cleaning the display surface, Use soft cloth with solvent [recommended below] and wipe lightly :

- .Isopropyl alcohol
- .Ethyl alcohol

Do not wipe the display surface with dry or hard materials that will damage the polarizer surface.

Do not use the following solvent :

- .Water
- .Aromatics

Do not wipe ITO pad area with the dry or hard materials that will damage the ITO patterns

Do not use the following solvent on the pad or prevent it from being contaminated :

- .Soldering flux
- .Chlorine (Cl) , Sulfur (S)

If goods were sent without being silicon coated on the pad, ITO patterns could be damaged due to the corrosion as time goes on.

If ITO corrosion happen by miss-handling or using some materials such as Chlorine (Cl), Sulfur (S) from customer, Responsibility is on customer.

12.3 Caution against static charge

The LCD module use C-MOS LSI drivers, so we recommended that you :

Connect any unused input terminal to Vdd or Vss, do not input any signals before power is turned on, and ground your body, work/assembly areas, assembly equipment to protect against static electricity.

12.4 Packing

Module employ LCD elements and must be treated as such.

- .Avoid intense shock and falls from a height.
- .To prevent modules from degradation, do not operate or store them exposed direct to sunshine or high temperature/humidity.

12.5 Caution for operation

- .It is an indispensable condition to drive LCD's within the specified voltage limit since the higher voltage then the limit cause the shorter LCD life.
- .An electrochemical reaction due to direct current causes LCD's undesirable deterioration, so that the use of direct current drive should be avoided.
- .Response time will be extremely delayed at lower temperature then the operating temperature range and on the other hand at higher temperature LCD's how dark color in them. However those phenomena do not mean malfunction or out of order with LCD's, which will come back in the specified operation temperature.
- .If the display area is pushed hard during operation, some font will be abnormally displayed but it resumes normal condition after turning off once.
- .A slight dew depositing on terminals is a cause for electro-chemical reaction resulting in terminal open circuit.
- .Usage under the maximum operating temperature, 50%Rh or less is required.
- .When fixed patterns are displayed for a long time,remnant image is likely to occur.

12.6 Storage

In the case of storing for a long period of time for instance, for years for the purpose or replacement use, the following ways are recommended.

- .Storing in an ambient temperature 10°C to 30°C, and in a relative humidity of 45% to 75%. Don't expose to sunlight or fluorescent light.
 - .Storing in a polyethylene bag with the opening sealed so as not to enter fresh air outside in it . And with no desiccant.
 - .Placing in a dark place where neither exposure to direct sunlight nor light's keeping the storage temperature range.
 - .Storing with no touch on polarizer surface by the anything else.
-

It is recommended to store them as they have been contained in the inner container at the time of delivery from us.

12.7 Safety

- .It is recommendable to crash damaged or unnecessary LCD's into pieces and wash off liquid crystal by either of solvents such as acetone and ethanol, which should be burned up later.
- .When any liquid leaked out of a damaged glass cell comes in contact with your hands, please wash it off well with soap and water.

13. PRECAUTION FOR USE

13.1 A limit sample should be provided by the both parties on an occasion when the both parties agreed its necessity. Judgment by a limit sample shall take effect after the limit sample has been established and confirmed by the both parties.

13.2 On the following occasions, the handing of problem should be decided through discussion and agreement between responsible of the both parties.

- .When a question is arisen in this specification.
- .When a new problem is arisen which is not specified in this specifications.
- .When an inspection specifications change or operating condition change in customer is reported to GTK, and some problem is arisen in this specification due to the change.
- .When a new problem is arisen at the customer's operating set for sample evaluation in the customer site.

14. PACKING SPECIFICATION

Please consult our technical department for detail information.

15. INITIALIZATION CODE

16. HSF COMPLIANCE

This products complies with ROHS 2011/65/EU and 2015/863/EU、REACH 1907/2006/EC requirements, and the packaging complies with 94-62-EC.

这个产品符合 ROHS 2011/65/EU 和 2015/863/EU、REACH 1907/2006/EC 要求，包材符合 94-62-EC 指令要求