

4

3

2

1

D

D

C

C

B

B

A

A

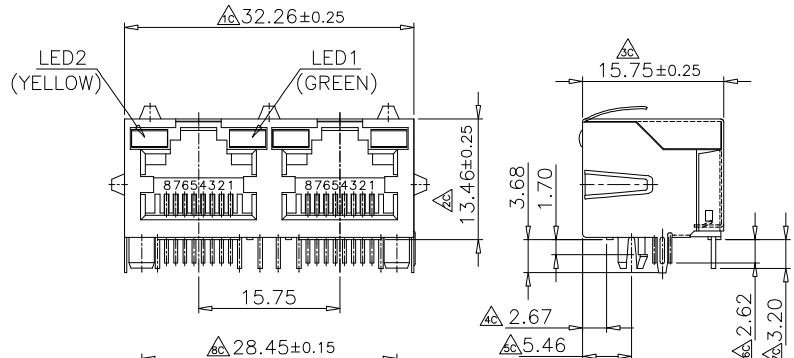

RoHS COMPLIANT

TYPICAL FOR SINGLE COLOR LED (RED, GREEN, YELLOW)

TYPICAL FOR BI-COLOUR LED

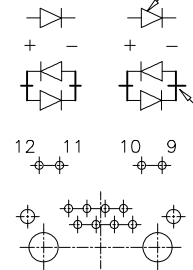

LED SCHEMATIC

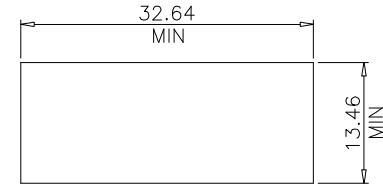
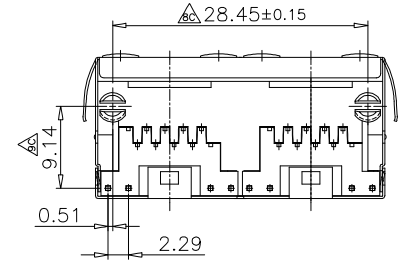
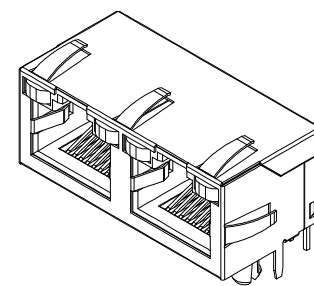

RECOMMENDED PANEL CUTOUT

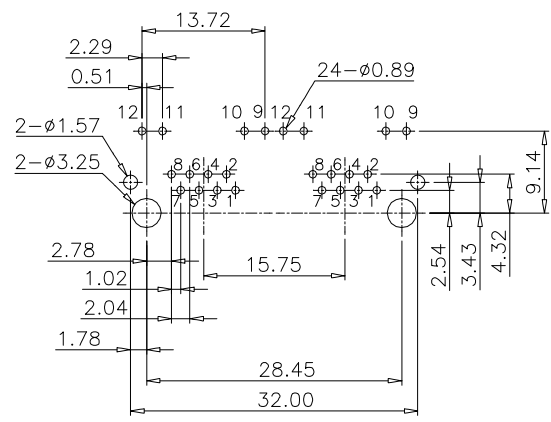

P.C.B LAYOUT/TOP VIEW

MATERIALS:
 PLASTIC HOUSING: ENGINEERING THERMOPLASTIC
 FLAMMABILITY RATING UL 94V-0.
 CONTACTS: PHOSPHOR BRONZE
 PLATING: GOLD PLATING OVER NICKEL IN CONTACT.
 TIN PLATING OVER NICKEL IN SOLDER AREA
 SHIELD: BRASS PLATING NICKEL ALLOY



TITLE	DUAL PORT MODULAR JACK WITH LED, SHIELDED WITH GROUNDING TABS	OPEN TOLERANCES Fraction Decimals Angles x ±0.50 ±1° x.X ±0.38 x.XX ±0.25 x.XXX ±0.10	DWG. Kate 11/02/10'		
PART NO.	MTCL-288xxSB-R	SCALE 2:1	CKD. Justin 11/02/10'	B	Update Drawing 11/02/10'
REF. NO.		QA. NO.	APPD. Justin 11/02/10'	A	New Release 06/09/09'
			REV.	DESCRIPTION	DATE

4

3

2

1

Order Information
 MTCL-288XXSB-R

Selective Gold Plating

- 0: Gold Falsh
- 1: 6u" Gold
- 2: 15u" Gold
- 3: 30u" Gold
- 4: 50u" Gold

LED Code

LED Code

CODE	LED 2<LEFT>	LED 1<Right>
0	NO LED	NO LED
1	Yellow	Green
2	NO LED	Green
3	Green	Yellow
4	Green	Green
5	Yellow	Yellow
6	Yellow/Green	Yellow/Green
7	Green /RED	Green /RED
8	Yellow/Green	Yellow
9	Green/Orange	Yellow

FURTHER LED OPTIONS AVAILABLE ON REQUEST



TITLE DUAL PORT MODULAR JACK WITH LED, SHIELDED WITH GROUNDING TABS		 OPEN TOLERANCES Fraction Decimals Angles x ±0.50 ± 1° x.x ±0.38 x.xx ±0.25 x.xxx ±0.10		DWG. Kate 11/02/10'		
PART NO. MTCL-288xxSB-R	REV. B	SCALE 2:1	SHEET 2 of 2	CKD. Justin 11/02/10'	B Update Drawing 11/02/10'	
REF. NO.	QA. NO.			APPD. Justin 11/02/10'	A New Release 06/09/09'	
				REV.	DESCRIPTION DATE	