

A4

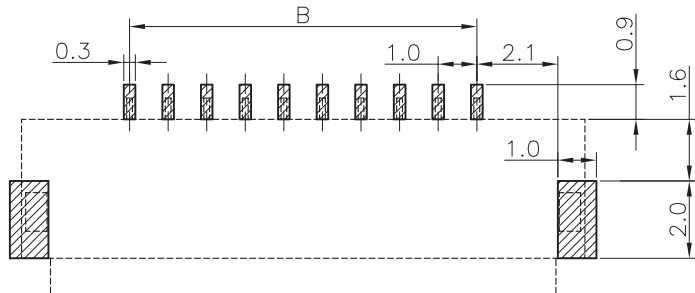

RECOMMENDED P.C.B LAYOUT(TOP VIEW)

GENERAL TOLERANCE: ±0.05

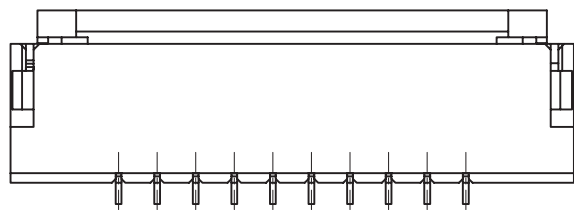
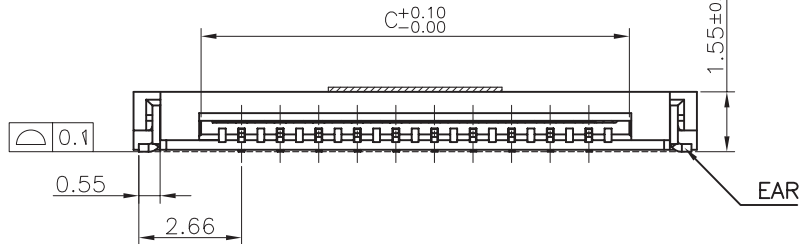
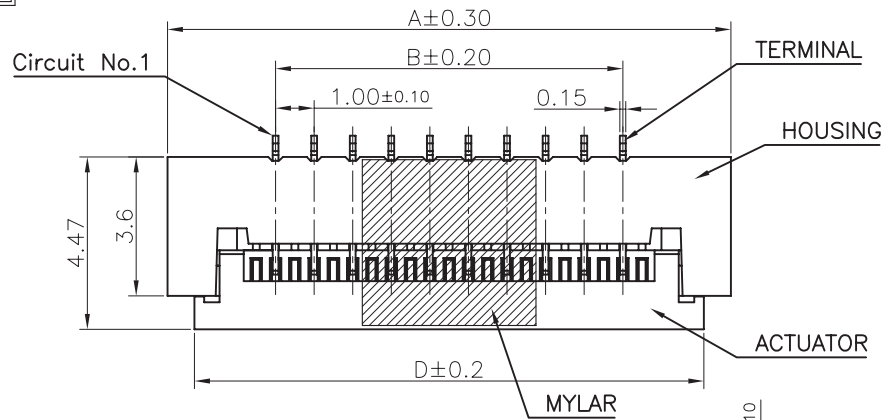
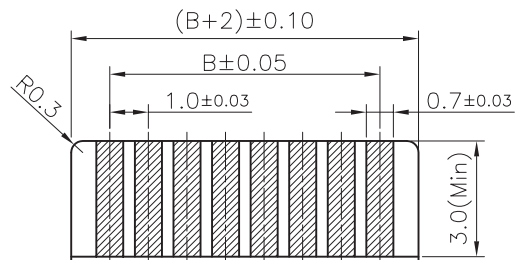
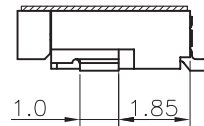
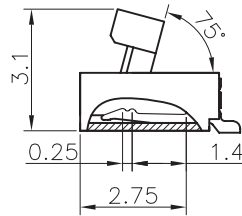

APPLICABLE FPC/FFC T=0.3±0.03

NOTES:

- MATERIAL: HOUSING: HIGH TEMP PLASTIC,UL94V-0
 COLOR: NORMAL: BLACK HALOGEN FREE: NATURE
 ACTUATOR: HIGH TEMP PLASTIC,UL94V-0
 COLOR: NORMAL: NATURE HALOGEN FREE: BLACK
 TERMINAL&EAR: COPPER ALLOY
 PLATING: Tin over nickel

ORDER CODE:

ZIFLXX-1.0BFX-R

Number of
Contacts

Blank-no mylar
M-with mylar

Poles	A	B	C	D
04	8.60	3.00	5.10	7.20
05	9.60	4.00	6.10	8.20
06	10.60	5.00	7.10	9.20
07	11.60	6.00	8.10	10.20
08	12.60	7.00	9.10	11.20
09	13.60	8.00	10.10	12.20
10	14.60	9.00	11.10	13.20
11	15.60	10.00	12.10	14.20
12	16.60	11.00	13.10	15.20
13	17.60	12.00	14.10	16.20
14	18.60	13.00	15.10	17.20
15	19.60	14.00	16.10	18.20
16	20.60	15.00	17.10	19.20
17	21.60	16.00	18.10	20.20
18	22.60	17.00	19.10	21.20
19	23.60	18.00	20.10	22.20
20	24.60	19.00	21.10	23.20
21	25.60	20.00	22.10	24.20
22	26.60	21.00	23.10	25.20
23	27.60	22.00	24.10	26.20
24	28.60	23.00	25.10	27.20
25	29.60	24.00	26.10	28.20
26	30.60	25.00	27.10	29.20
27	31.60	26.00	28.10	30.20
28	32.60	27.00	29.10	31.20
29	33.60	28.00	30.10	32.20
30	34.60	29.00	31.10	33.20

X. ± 0.40	X.* ± 5.0*	UNITS: mm	GTK UK LTD.						
.X ± 0.30	.X* ± 2.0*	MATERIAL:							
.XX ± 0.20	.XX* ± 1.0*	SEE NOTE	PART NO. ZIFLXX-1.0BF-R						
.XXX ± 0.10	.XXX* ± --	FINISH:	APPD:						
		SEE NOTE	CHKD:						
		Q'TY:	DR: sunquan 2012/06/05						
		SEE NOTE	<table border="1"> <tr> <td>SCALE</td> <td>SHEET</td> <td>REV.</td> </tr> <tr> <td>5:1</td> <td>1/1</td> <td>A</td> </tr> </table>	SCALE	SHEET	REV.	5:1	1/1	A
SCALE	SHEET	REV.							
5:1	1/1	A							

GTK UK LTD.

TITLE: 1.0mm ZIF connector
1.55mm height.with flip
actuator.bottom contacts

DWG NO.:
020-0118-1003A-XX

SCALE	SHEET	REV.
5:1	1/1	A