

REV.	ECN NO	LOCATIONS	DESCRIPTION	DATE	REVISER	APPD

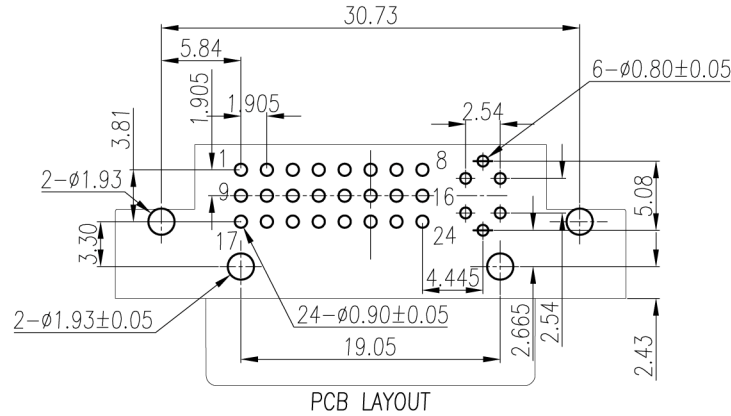
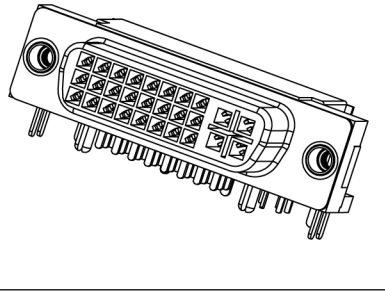

MATERIAL

- INSULATOR: NYLON, WHITE (UL94V-0)
- CONTACT: PHOSPHOR BRONZE
- CONTACT PLATING: SELECTIVE GOLD OVER NICKEL
- SHELL: STEEL, NICKEL PLATED

SPECIFICATION

- CURRENT RATING: 1A max
- DIELECTRIC WITHSTAND VOLTAGE: 500V (AC) for 1 minute
- CONTACT RESISTANCE: 30milliohms max
- INSULATION RESISTANCE: 1000 Megohms min at DC500V
- OPERATING TEMP: -55°C~105°C

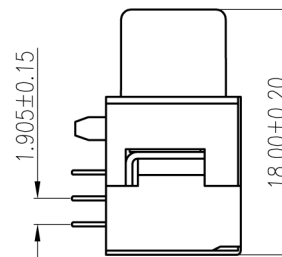
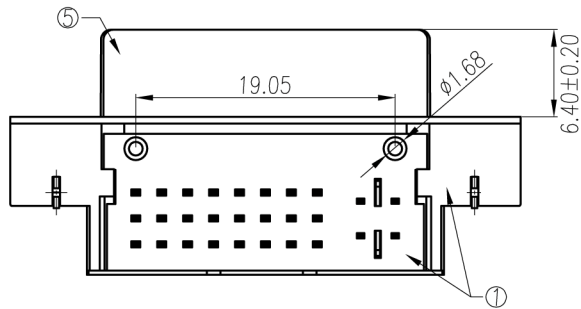
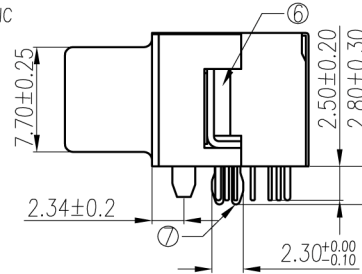
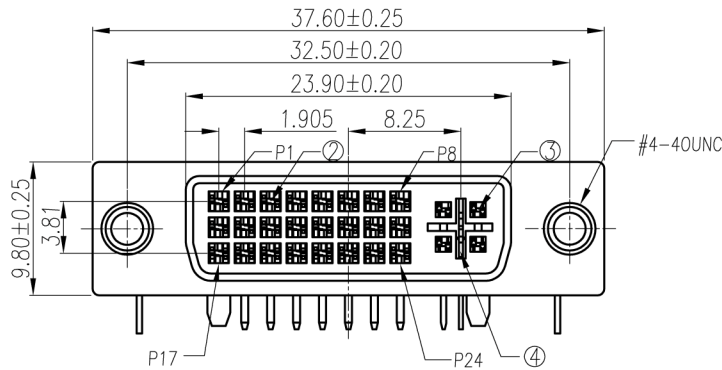

VIEW DIGITAL CONTACT

PART NO:		MATERIAL:		 GTK UK LTD.
MODEL NO:		FINSH:		
UNIT: mm	SIZE: A4	COLOR:		
TOLERANCE UNSPECIFIED		DR: 趙承寶 '07/05/03		DVI-I (24+5) RIGHT-ANGLED RECEPTACLE WITH PEGS, BOARDLOCKS AND 4-40UNC THREADED HOLES
.x	±0.30	CHK: James '07/05/03		
.xx	±0.20	APP: Kent '07/05/03		DWG NO: DVL245SN2NS-R
.xxx	±0.10	SCALE: 2:1		REV: A0
ANG.	±1°	SHEET: 1 of 1		